



Invacare® Platinum™ 10L Oxygen Concentrator

IRC10LX

en **HomeFill® System Compatible**
User Manual

This manual **MUST** be given to the user of the product.
BEFORE using this product, read this manual and save for future reference.



Yes, you can.®

© 2016 Invacare® Corporation

All rights reserved. Republication, duplication or modification in whole or in part is prohibited without prior written permission from Invacare. Trademarks are identified by ™ and ®. All trademarks are owned by or licensed to Invacare Corporation or its subsidiaries unless otherwise noted.

Making Life's Experiences Possible is a trademark in the U.S.A.

Pine-sol and Lestoil are registered trademarks of The Clorox Company.

Dawn is a registered trademark of The Proctor and Gamble Company.

Contents

I General	4
1.1 Symbols	4
1.2 Intended Use	5
1.3 Indications For Use	6
1.4 Description	6
1.5 Contraindications	6
2 Safety	7
2.1 Label Locations	7
2.2 General Guidelines	9
2.3 Radio Frequency Interference	12
3 Components	13
3.1 Component Identification	13
3.2 Pneumatic Diagram	14
4 Accessories	15
4.1 Optional Accessories	15
5 Setup	16
5.1 Unpacking	16
5.2 Inspection	16
5.3 Storage	16
6 Usage	17
6.1 Introduction	17
6.2 Select a Location	17
6.3 Setting Up the Concentrator	18
6.3.1 Setting Up the Humidifier	18
6.3.2 Turning the Concentrator On	20
6.3.3 Flowrate	21
6.3.4 Units without SensO ₂	21

7 Maintenance	22
7.1 Service Life	22
7.2 Cleaning the Cabinet	22
7.3 Cleaning the Cabinet Filter	23
7.4 Humidifier Cleaning and Thermic Disinfection	24
7.5 Cleaning and Disinfection Between Patients	24
7.6 Preventive Maintenance Checklist	25
8 After Use	26
8.1 Recycling Information	26
8.2 Wear and Tear	26
9 Troubleshooting	27
9.1 Troubleshooting	27
10 Technical data	28
10.1 Specifications	28
11 Warranty	31
11.1 North American Limited Warranty	31

I General

I.1 Symbols

Signal words are used in this manual and apply to hazards or unsafe practices which could result in personal injury or property damage. See the information below for definitions of the signal words.



DANGER!

– Danger indicates an imminently hazardous situation which, if not avoided, will result in death or serious injury.



WARNING!

– Warning indicates a potentially hazardous situation which, if not avoided, could result in death or serious injury.



CAUTION!

– Caution indicates a potentially hazardous situation which, if not avoided, may result in property damage or minor injury or both.



Gives useful tips, recommendations and information for efficient, trouble-free use.



Refer to the following table for the meaning of symbols marked on the equipment and/or packaging.

Symbols in Documentation



General Warning Sign



The background color inside the triangle is yellow on product labels.



Read manual



The color of the symbol background is blue on product labels.



No Smoking



The color of the circle with diagonal bar is red on product labels.



No Open Flame



The color of the circle with diagonal bar is red on product labels.



Class II, Double Insulated

IPX1

Protected against solid foreign objects of 12.5 mm diameter and greater.

Protected against vertically falling water drops.



Indoor Use ONLY



Keep Dry



Transport and Storage Temperature



Transport and Storage Humidity



Alternating Current



Type BF equipment



Recycle



DO NOT dispose of in household waste



Electrical Hazard



Manufacturer



Call supplier

Symbols on Product



Unit running



Unit not running

LX Indicators

Symbol	O ₂ Purity	Indicator Lights (LED)
I/O	SYSTEM OKAY	GREEN Indicator Light
	SYSTEM FAILURE	RED Indicator Light Continuous Audible Alarm Sieve — GARD™ Compressor Shutdown Call a qualified technician.

1.2 Intended Use

The intended function and use of the Invacare® Platinum™ Oxygen Concentrator is to provide supplemental oxygen to patients with respiratory disorders, by separating nitrogen from room air, by way of a molecular sieve. It is not intended to sustain or support life.



DANGER!

Risk of Injury or Death

This product is to be used as an oxygen supplement and is not intended to be life-supporting or life-sustaining. ONLY use this product if the patient is capable of spontaneous breath, able to inhale and exhale without the use of a machine.

- DO NOT use in parallel or series with other oxygen concentrators or oxygen therapy devices.



DANGER!

Risk of Injury or Death

Depending on their medical condition, patients on flowrates greater than 5 L/min may be at an increased risk for serious injury or death in the event of failure.

- ALWAYS discuss this increased risk with your health care supplier BEFORE using this product if you are prescribed a flowrate greater than 5 L/min.



WARNING!

Risk of Injury or Damage

Use of this product outside of the intended use and specifications has not been tested and may lead to product damage, loss of product function, or personal injury.

- DO NOT use this product in any way other than described in the Specifications and Intended Use sections of this manual.



DANGER!

Risk of Injury or Death

While Invacare strives to produce the best oxygen concentrator in the market today, this oxygen concentrator can fail to produce oxygen due to power failure or device malfunction.

- ALWAYS have a backup source of oxygen readily available.
- In the event the concentrator fails to produce oxygen, the concentrator will briefly alarm signaling the patient to switch to their backup source of oxygen. Refer to Troubleshooting for more detail.

1.3 Indications For Use

The intended function and use of the Invacare® Platinum™ Oxygen Concentrator is to provide supplemental oxygen to patients with respiratory disorders, by separating nitrogen from room air, by way of a molecular sieve. It is not intended to sustain or support life.

1.4 Description

The Invacare Platinum concentrator is used by patients with respiratory disorders who require supplemental oxygen. The device is not intended to sustain or support life.

The oxygen concentration level of the output gas ranges from 87% to 95.6%. The oxygen is delivered to the patient through the use of a nasal cannula.

The Invacare Platinum concentrator uses a molecular sieve and pressure swing adsorption methodology to produce the oxygen gas output. Ambient air enters the device, is filtered and then compressed. This compressed air is then directed toward one of two nitrogen adsorbing sieve beds.

Concentrated oxygen exits the opposite end of the active sieve bed and is directed into an oxygen reservoir where it is delivered to the patient.

The Invacare Platinum concentrator is capable of operation by the patient in a home environment or in an institutional environment. Device operates at a nominal 120 VAC/60 Hertz supply.

Service information will be available upon request to qualified technical personnel only.

1.5 Contraindications

There are no known contraindications.

2 Safety

2.1 Label Locations

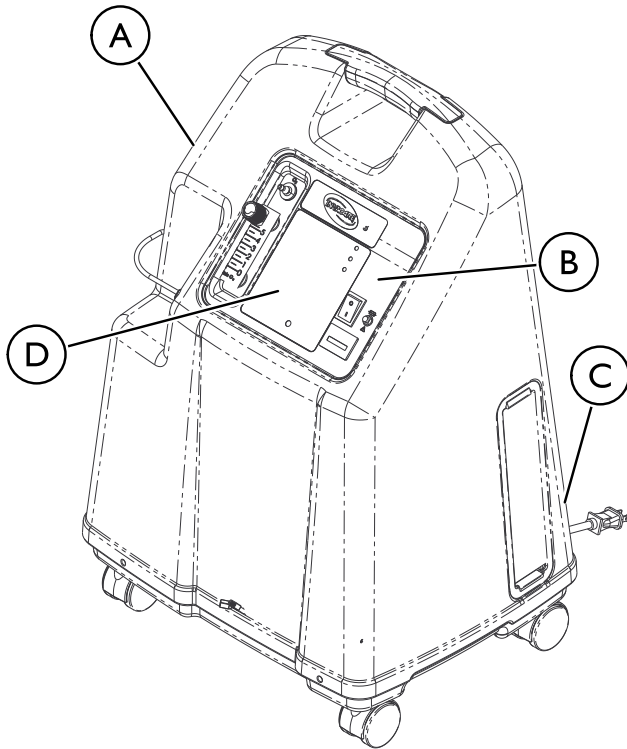

<p>Ⓐ</p>	<p>Serial Number Label is located on the resonator intake assembly.</p>
<p>Ⓑ</p>	 <p>The image shows a rectangular safety sign with a black border. At the top, there is a circular symbol with a diagonal slash over a lit cigarette. Below the symbol, the text reads: <ul style="list-style-type: none"> NO SMOKING NO fumar Escape non fumeur At the bottom of the sign, in smaller text, it says "P/N 1154274 Rev B". </p>
<p>Ⓒ</p>	<p>Specification and Double Insulation Label is located on the back of the concentrator at the base</p>

IRC10LX

HomeFill® Compatible



SEE USER MANUAL OR
CONTACT YOUR HOME
EQUIPMENT PROVIDER FOR
SAFE OPERATING
INSTRUCTIONS, ALARMS,
AUDIBLE ALERTS AND USE OF
ACCESSORIES.

I/O

⚠ DANGER



**RISK OF FIRE - NO SMOKING, OPEN
FLAME OR IGNITION SOURCES**

Keep ALL sources of ignition out of the room in which this product is located and away from areas where oxygen is being delivered. Textiles, oil and other combustibles are easily ignited and burn with great intensity in oxygen enriched air.

⚠ DANGER

RISK OF ELECTRIC SHOCK

DO NOT remove cover. Refer servicing to qualified service personnel.

Ⓓ

2.2 General Guidelines

In order to ensure the safe installation, assembly and operation of the concentrator these instructions **MUST** be followed.



DANGER!

Risk Of Death, Injury, Or Damage

Improper use of the product may cause death, injury or damage. This section contains important information for the safe operation and use of this product.

- DO NOT use this product or any available optional equipment without first completely reading and understanding these instructions and any additional instructional material such as user manuals, service manuals or instruction sheets supplied with this product or optional equipment.
- If you are unable to understand the warnings, cautions or instructions, contact a healthcare professional, dealer or technical personnel before attempting to use this equipment.
- Check ALL external components and carton for damage. In case of damage, or if the product is not working correctly, contact a technician or Invacare for repair.
- THE INFORMATION IN THIS DOCUMENT IS SUBJECT TO CHANGE WITHOUT NOTICE.



DANGER!

Risk Of Death, Injury, Or Damage From Fire

Textiles, oil or petroleum substances, grease, greasy substances and other combustibles are easily ignited and burn with great intensity in oxygen enriched air and when in contact with oxygen under pressure. To avoid fire, death, injury or damage:

- DO NOT SMOKE while using this device.
- DO NOT use near OPEN FLAME or IGNITION SOURCES.
- DO NOT use any lubricants on concentrator unless recommended by Invacare.
- NO SMOKING signs should be prominently displayed.
- Avoid creation of any spark near oxygen equipment. This includes sparks from static electricity created by any type of friction.
- Keep all matches, lighted cigarettes, electronic cigarettes or other sources of ignition out of the room in which this concentrator is located and away from where oxygen is being delivered.
- Keep the oxygen tubing, cord, and concentrator out from under such items as blankets, bed coverings, chair cushions, clothing, and away from heated or hot surfaces including space heaters, stoves, and similar electrical appliances.



CAUTION!

Federal (statutory) law restricts this device sale to or on the order of a medical practitioner licensed by a governmental agency where he/she practices.

- ONLY a licensed medical practitioner may order the purchase or use of this device.



DANGER!

Risk of Death, Injury, from Electric Shock

To reduce the risk of burns, electrocution, death or injury to persons:

- DO NOT disassemble. Refer servicing to qualified service personnel. There are no user serviceable parts.
- Avoid using while bathing. If continuous usage is required by the physician's prescription, the concentrator must be located in another room at least 7ft (2.1m) from the bath.
- DO NOT come in contact with the concentrator while wet.
- DO NOT place or store concentrator where it can drop into water or other liquid.
- DO NOT reach for concentrator that has fallen into water. Unplug IMMEDIATELY.
- DO NOT use frayed or damaged AC power cords.



WARNING!

Risk Of Injury Or Damage

- Invacare products are specifically designed and manufactured for use in conjunction with Invacare accessories. Accessories designed by other manufacturers have not been tested by Invacare and are not recommended for use with Invacare products.
- There are many different types of humidifiers, oxygen tubing, cannulas and masks that can be used with this device. You should contact your local home care supplier for recommendations on which of these devices will be best for you. They should also give you advice on the proper usage, maintenance, and cleaning.



DANGER!

Risk of Injury or Death

To avoid choking or ingestion of chemicals from airway contamination:

- DO NOT use the concentrator in the presence of pollutants, smoke, fumes, flammable anesthetics, cleaning agents, or chemical vapors.



WARNING!

Risk of Injury or Death

To prevent injury or death from product misuse:

- Closely supervise when this concentrator is used by or near children or impaired individuals.
- Monitor patients using this device who are unable to hear or see alarms or communicate discomfort.



WARNING!

Risk of Injury or Death

To avoid choking and/or strangulation from tubing entanglement:

- Keep children and pets away from nasal cannula and tubing.
- Close supervision is necessary when the nasal cannula is used by or near children and/or impaired persons.



WARNING!

Risk of Injury or Death

To reduce the risk of injury or death from illness:

- Replace the nasal cannula on a regular basis. Check with your equipment supplier or physician to determine how often the cannula should be replaced.
- DO NOT share cannulas between patients.

**WARNING!****Risk of Injury**

A change in altitude may affect total oxygen available to you. To prevent oxygen deprivation:

- Consult your physician before traveling to higher or lower altitudes to determine if your flow settings should be changed.

**WARNING!****Risk of Injury or Damage**

To prevent injury or damage from cord misuse:

- DO NOT move or relocate concentrator by pulling on the cord.
- DO NOT use extension cords with AC power cord provided.
- Properly store and position electrical cords and/or tubing to prevent a tripping hazard.

**WARNING!****Risk of Injury or Damage**

To prevent injury or damage from misuse:

- NEVER leave concentrator unattended when plugged in.
- Make sure concentrator is off when not in use.

**WARNING!****Risk of Injury or Damage**

Invacare oxygen concentrators are specifically designed to minimize routine preventive maintenance. To prevent injury or damage:

- Only professionals of the healthcare field or persons fully conversant with this process such as factory trained personnel should perform preventive maintenance or performance adjustments on the oxygen concentrator, except for tasks described in this manual.
- Users should contact your dealer or Invacare for service.

**CAUTION!****Risk of Damage**

To prevent damage from liquid ingress:

- If the concentrator is not working properly, if it has been dropped or damaged, or dropped into water, call equipment supplier/qualified technician for examination and repair.
- NEVER drop or insert any object or liquid into any opening.
- For Indoor Use ONLY.

2.3 Radio Frequency Interference



WARNING!

Risk of Injury or Damage

To reduce the risk of injury or product damage from interference with wireless equipment:

- Keep concentrator at least 9.8 ft (3.0 m) away from wireless communication equipment such as wireless home network devices, mobile phones, cordless phones and base stations, walkie-talkies, etc.

This equipment has been tested and found to comply with EMC limits specified by IEC/EN 60601-1-2. These limits are designed to provide a reasonable protection against electromagnetic interference in a typical medical installation.

Other devices may experience interference from even the low levels of electromagnetic emissions permitted by the above standards.

To determine if the emissions from the concentrator are causing the interference, turn the concentrator Off. If the interference with the other device(s) stops, then the concentrator is causing the interference. In such rare cases, interference may be reduced or corrected by one of the following measures:

- Reposition, relocate, or increase the separation between the equipment.
- Connect the equipment into an outlet on a circuit different from that to which the other device(s) is connected.

3 Components

3.1 Component Identification

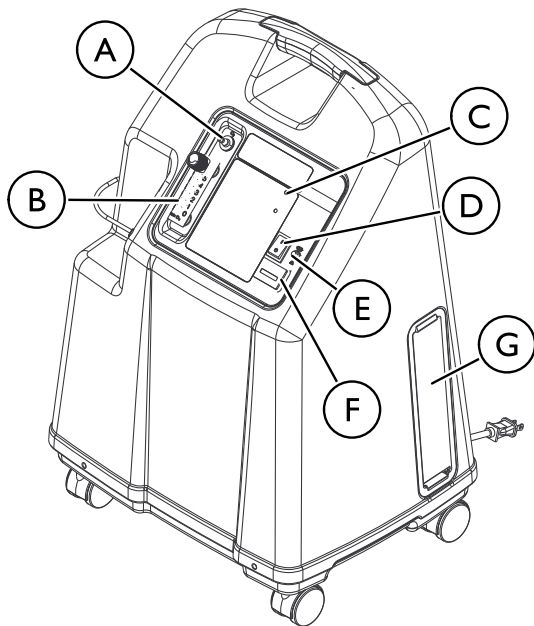

A	Oxygen Outlet
B	Flowmeter
C	Fault and Power Indicator Lights
D	Power Switch

E	Circuit Breaker
F	Elapsed Time Meter
G	Cabinet Filter

Rear View

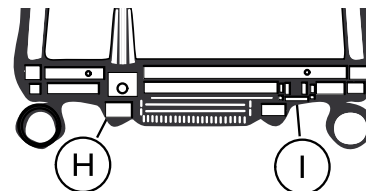

H	Power Cord
I	HomeFill Outlet Fitting



Accessories (Not Shown): HomeFill home oxygen compressor — IOH200

The HomeFill outlet fitting ① is to be used only for filling oxygen cylinders with the HomeFill home oxygen compressor. The outlet fitting does not affect concentrator performance. Refer to the HomeFill user manual, part number I100873, for connection and operating instructions. When not in use, the plug provided with the concentrator should be inserted into the outlet fitting. For more information about the HomeFill, contact your Invacare dealer.

3.2 Pneumatic Diagram

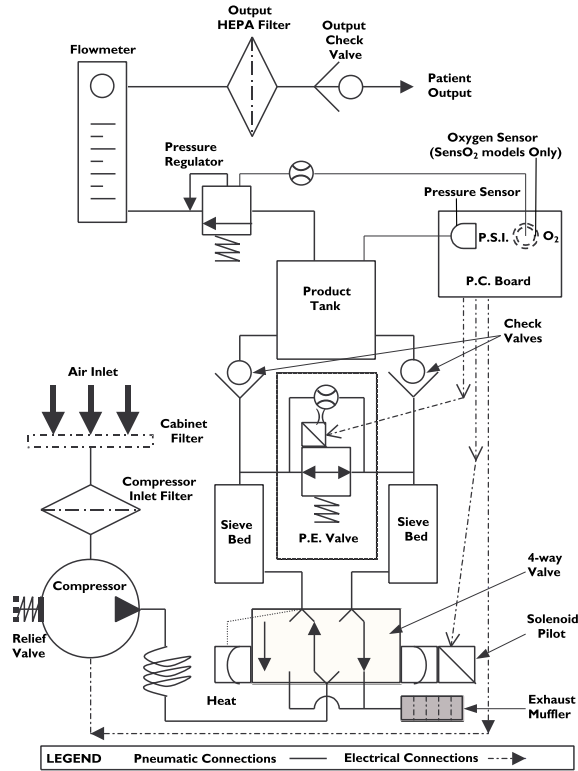

4 Accessories

4.1 Optional Accessories

There are many different types of humidifiers, oxygen tubing, cannulas and masks that can be used with this device. You should contact your local home care provider for recommendations on which of these devices will be best for you. They should also give you advice on the proper usage, maintenance, and cleaning.

The supply accessories (nasal cannula, mask, tubing, humidifier, etc.) used to deliver oxygen to the patient need to include a means to reduce the propagation of fire in the accessories for the safety of the patient and others. If a commercially available, fire-activated flow stop device is used in the accessories setup, it should be placed as close to the patient as possible.

- Standard Adult Nasal Cannula, 7 ft (2.1 m) M3120
- Standard Humidifier - Invacare Part #1155719
- HomeFill Home Oxygen Compressor - IOH200
- Oxygen Supply Tubing 7 ft (2.1 m) - MS4107
- Oxygen Supply Tubing 21 ft (6.3 m) - MS4121
- Oxygen Tubing Connector - MS4301

5 Setup

5.1 Unpacking

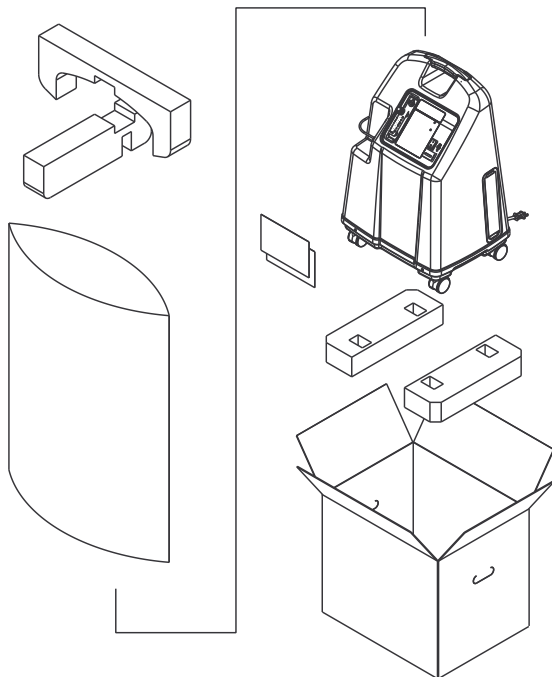

1. Check for any obvious damage to the carton or its contents. If damage is evident, notify the carrier, or your local dealer.
2. Remove all loose packing from the carton.
3. Carefully remove all the components from the carton.

 Unless the oxygen concentrator is to be used **IMMEDIATELY**, leave concentrator in its packaging for storage until use is required.

5.2 Inspection

1. Inspect/examine exterior of the concentrator for nicks, dents, cracks, scratches or other damage.
2. Inspect all components.

5.3 Storage

1. Store the repackaged oxygen concentrator in a dry area. Refer to Specifications for storage temperature parameters.
2. **DO NOT** place objects on top of repackaged concentrator.

6 Usage

6.1 Introduction

Your oxygen concentrator is intended for individual use indoors. It is an electronically operated device that separates oxygen from room air. It provides high concentration of oxygen directly to you through a nasal cannula. Clinical studies have documented that oxygen concentrators are therapeutically equivalent to other types of oxygen delivery systems.

Your supplier will show you how to use your oxygen concentrator. He/She should be contacted with any questions or problems regarding your oxygen concentrator. This user manual will tell you about your concentrator and will serve as a reference as you use your concentrator.

6.2 Select a Location



WARNING!
Risk of Injury

To avoid injury during therapy:

- The oxygen concentrator **MUST** be placed on a level surface for use.
- **DO NOT** relocate the oxygen concentrator while in use.



WARNING!

Risk of Injury or Damage

To avoid injury or damage from airborne pollutants and/or fumes and for optimal performance:

- Locate and position the concentrator in a well ventilated space so that the air intake and the air exhausts are not obstructed.
- **NEVER** block the air openings of the concentrator or place it on a soft surface, such as a bed or couch, where the air opening may be blocked.
- Keep the openings free from lint, hair and similar foreign items.
- Keep concentrator at least 12 in (30.5 cm) away from walls, draperies and furniture.
- Avoid use in presence of pollutants, smoke or fumes, flammable anesthetics, cleaning agents or chemical vapors.
- Place concentrator in a well ventilated area to avoid airborne pollutants and/or fumes.
- **DO NOT** use in a closet.

You may select a room in your house where using your oxygen concentrator would be most convenient. Your concentrator can be easily rolled from room to room on its casters.

Your oxygen concentrator will perform best when operated under the conditions outlined in Specifications.

Usage in environments other than those described may result in the need for increased equipment maintenance. The air intake of the unit should be located in a well ventilated area to avoid airborne pollutants and/or fumes.

6.3 Setting Up the Concentrator

1. Plug in power cord to an electrical outlet.
2. Connect Humidifier (if so prescribed).

6.3.1 Setting Up the Humidifier



WARNING!

Risk of Injury or Damage

To avoid burns from steam or hot water, inhalation of water and/or water damage to the concentrator:

- DO NOT fill humidifier bottle with hot water. Allow boiled water to cool to room temperature before filling.
- DO NOT overfill humidifier.
- Replace the humidifier cap and securely tighten. Confirm that the cap is not cross-threaded on the humidifier bottle.
- DO NOT reverse the oxygen input and output connections. Water from the humidifier bottle will travel through the cannula back to the patient if input and output connections are reversed.
- When using tubing connections longer than 7 ft (2.1 m) in length, position the humidifier as close to the patient as possible to allow for maximum humidification output.



WARNING!

Risk of Injury or Damage

Failure to properly install the humidifier bottle or other accessories to the concentrator will impact the flow of oxygen.

- To check for proper operation of the oxygen concentrator and accessories, place the end of the nasal cannula under the surface of a half-full cup of water only when the oxygen is flowing and look for bubbles indicating proper operation. Wipe any excess water off the nasal prongs when finished before placing on the patient.
- If there are no bubbles, check all connections (including humidifier bottle and other accessories, if applicable) and repeat. Contact your dealer or service supplier immediately if bubbles still do not appear.

Humidifier Bottle with Cap

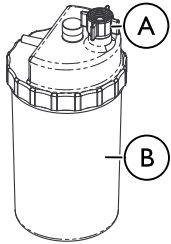

Humidifier Bottle without Cap



1. Remove cap **A** from bottle **B**.
2. Fill humidifier bottle with boiled tap water or bottled water to the level indicated by the manufacturer. Boil tap water for approximately ten minutes and cool to room temperature prior to use.



CAUTION! Risk of Damage

- Confirm the humidifier cap is not cross-threaded on the humidifier bottle.

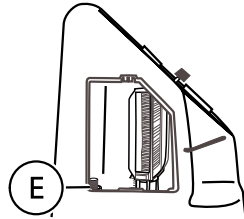
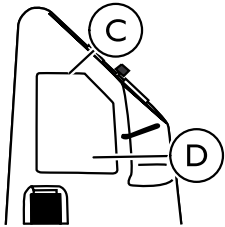

3. Insert a flathead screwdriver in the plate groove **C** on the top edge of the filter access door **D** and gently pry the filter access door off.

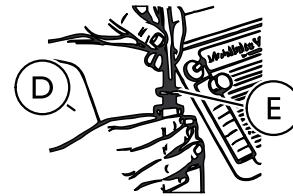

4. Pull up and remove the humidifier bottle adapter **E** (next to inlet filter).

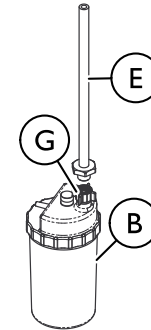

WARNING! Risk of Injury

- To avoid impacting the flow of oxygen:
- Install the humidifier bottle and/or other accessories properly.

5. Attach the humidifier bottle adapter (E) to the humidifier bottle (B) by turning the wing nut (C) on the humidifier bottle counterclockwise until it is securely fastened.



6. When placing the humidifier bottle in the compartment (F) on the concentrator, attach the humidifier bottle/adapter tube (H) to the oxygen outlet connector (I) on the concentrator.

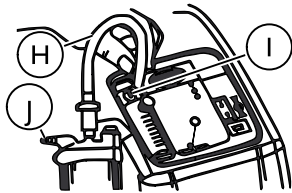

 When using tubing connections longer than 7 ft (2.1 m) in length, position the humidifier as close to the patient as possible to allow for maximum humidification output.

7. Attach the patient's nasal cannula supply tube to the humidifier bottle outlet (J).
8. After assembly, ensure that oxygen is flowing through the nasal cannula.
9. Replace the filter access door on the side of concentrator by snapping it back into the plate groove.

6.3.2 Turning the Concentrator On

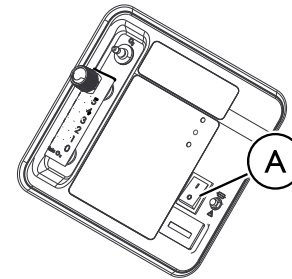

- I. Press power switch (A) to On position.

 All the panel lights and the audible alarm will come on for one second, confirming that the indicators are functioning properly.

6.3.3 Flowrate



WARNING! **Risk of Injury**

To avoid injury from excess oxygen or a deficit of oxygen:

- DO NOT change the L/min setting on the flowmeter unless a change has been prescribed by your physician or therapist.
- DO NOT set the flow greater than 10 L/min.

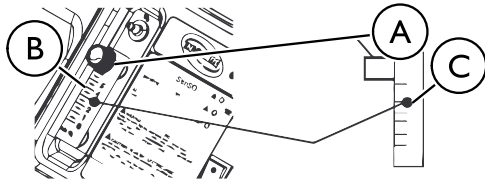

1. Turn the flowrate knob **A** to the setting prescribed by your physician or therapist.



To properly read the flowmeter **B**, locate the prescribed flowrate line on the flowmeter. Next, turn the flow knob until the ball **C** rises to the line. Now, center the ball on the L/min line prescribed.

2. If the flowrate on the flowmeter ever falls below 1 L/min for more than about one minute, the Potential Obstruction Alert will be triggered. This is a rapid beeping of the audible alarm. Check your tubing or accessories for blocked or kinked tubing or a defective humidifier bottle. After rated flow is restored to 1 L/min, the Potential Obstruction Alert will turn off.





A Potential Obstruction Alert indicates a condition that may be associated with a partial or complete obstruction of oxygen output.

The use of some accessories and the HomeFill compressor will deactivate the Potential Obstruction Alert.

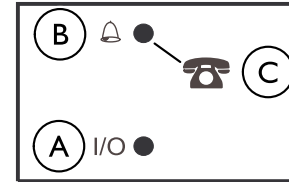
6.3.4 Units without SensO₂



Concentrator may be used during the initial start warm-up time (approximately 30 min). O₂ purity will build to a maximum during this period.

	Light	Symbol	Explanation
A	GREEN light	I/O	Normal Operation
B	RED light		Continuous Audible Alarm Sieve-GARD™ Compressor Total unit shutdown. Immediately switch to backup oxygen supply and call supplier.
C	—		Call Supplier

7 Maintenance

7.1 Service Life



WARNING!

Risk of Injury or Damage

Use of the product beyond this time period may cause product damage and injury.

- This product has an expected lifetime of three (3) years when used in accordance with safety instructions, maintenance intervals and correct use stated in this manual.
- Perform all maintenance according to the recommended schedule in this manual.



The effective product lifetime can vary according to frequency and intensity of use.

7.2 Cleaning the Cabinet



DANGER!

Risk of Injury or Damage

Invacare oxygen concentrators are specifically designed to minimize routine preventive maintenance. To prevent injury or damage:

- Only qualified personnel should perform preventive maintenance on the oxygen concentrator.
- DO NOT remove cabinet.



DANGER!

Risk of Injury or Damage

Liquid will damage the internal components of the concentrator. To avoid damage or injury from electrical shock:

- Turn Off the concentrator and unplug the power cord before cleaning.
- DO NOT allow any cleaning agent to drip inside the air inlet and outlet openings.
- DO NOT spray or apply any cleaning agent directly to the cabinet.
- DO NOT hose down the product.



CAUTION!

Risk of Damage

Harsh chemical agents can damage the concentrator. To avoid damage:

- DO NOT clean the cabinet or filter with alcohol and alcohol based products (isopropyl alcohol), concentrated chlorine-based products (ethylene chloride), and oil-based products (Pine-Sol®, Lestoil®) or any other harsh chemical agents. Only use mild liquid dish detergent (such as Dawn®).



At a minimum, preventive maintenance **MUST** be performed according to the maintenance record guidelines. In places with high dust or soot levels, maintenance may need to be performed more often. Refer to the Preventative Maintenance Checklist.

Periodically clean the concentrator's cabinet as follows:

1. Use a damp cloth, or sponge, with a mild detergent such as Dawn dish washing soap to gently clean the exterior case.
2. Allow the concentrator to air dry, or use a dry towel, before operating the concentrator.

7.3 Cleaning the Cabinet Filter



CAUTION!

Risk of Damage

To avoid damage to the internal components of the unit:

- DO NOT operate the concentrator without the filter installed or with a dirty filter.



There are two cabinet filters located on each side of the cabinet.

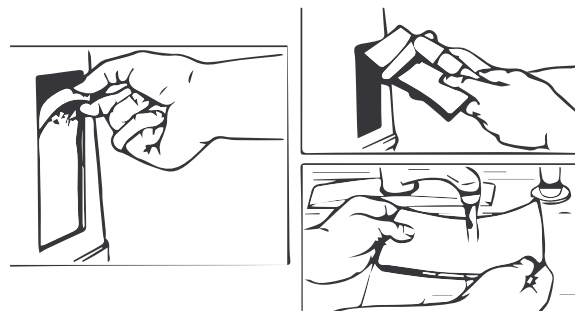
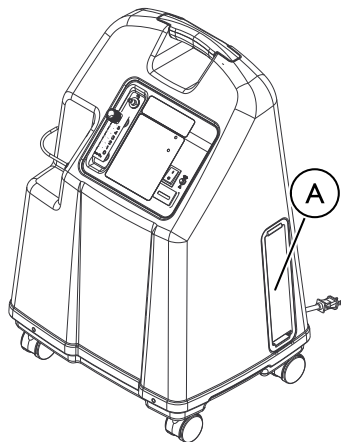

1. Remove the filter **A** and clean as needed.



Environmental conditions that may require more frequent inspection and cleaning of the filter include, but are not limited to: high dust, air pollutants, etc.

2. Clean the cabinet filter with a vacuum cleaner or wash with a mild liquid dish detergent (such as Dawn) and water. Rinse thoroughly.
3. Thoroughly dry the filter and inspect for fraying, crumbling, tears and holes. Replace filter if any damage is found.
4. Reinstall the cabinet filter.

7.4 Humidifier Cleaning and Thermic Disinfection

 Clean and disinfect the oxygen humidifier daily to reduce limestone deposits and eliminate possible bacterial contamination. Follow the instructions provided by the manufacturer. If none are provided, follow these steps:

1. Wash humidifier in soapy water and rinse with a solution of ten parts water and one part vinegar.
2. Rinse thoroughly with hot water.
3. Air dry thoroughly.

 To limit bacterial growth, air dry the humidifier thoroughly after cleaning when not in use. Refer to Set Up for use.

7.5 Cleaning and Disinfection Between Patients



WARNING!

Risk of Injury or Damage

To prevent injury from infection or damage to concentrator:

- Only qualified personnel should perform cleaning and disinfection of the oxygen concentrator and accessories between patients.

 Follow these instructions to eliminate possible pathogen exchange between patients due to contamination of components or accessories. Preventive maintenance should also be performed at this time if necessary.

1. Dispose of and replace all patient side accessories not suitable for multiple patient use, including but not limited to:
 - Nasal Cannula and Tubing
 - Mask
 - Humidifier
2. Perform maintenance procedures described in this manual and items on the Preventive Maintenance Checklist.
3. Check concentrator for possible external damage or signs that it may require service or repair.
4. Ensure concentrator functions properly and all alarms are in working order.
5. Before repackaging and distribution to new patient, ensure packaging contents contain the concentrator and user manual.

7.6 Preventive Maintenance Checklist

Model No:	Serial No:						
ON EACH INSPECTION							
Record Date of Service							
Record Elapsed Hours on Hour Meter							
Clean Cabinet Filter(s) (Refer to Cleaning the Cabinet Filter.)							
Check Prescribed L/min. Flow Rate							
DURING PREVENTIVE MAINTENANCE SCHEDULE, OR BETWEEN PATIENTS							
UNITS WITHOUT SensO₂ — Every 6 months of continuous use (Equivalent to 4,380 hours)							
Check Oxygen Concentration (green indicator light)							
Clean/Replace Cabinet Filter(s) (Refer to Cleaning the Cabinet Filter.)							
Check/Replace Outlet HEPA Filter*							
Check/Replace Compressor Inlet Filter*							
Check Power Loss Alarm*							

26,820 hours are equivalent to usage 24 hours per day, 7 days per week for 3 years.

*To be conducted by provider or qualified service technician. Refer to service manual.

8 After Use

8.1 Recycling Information

This product may contain substances that could be harmful to the environment if disposed of in places (landfills) that are not appropriate according to legislation.

Follow local governing ordinances and recycling plans regarding disposal of the concentrator or components normally used in operation. The concentrator does not generate waste or residue in operation.

- DO NOT dispose of the concentrator in the normal waste stream.
- Any accessories not part of the concentrator MUST be handled in accordance with the individual product marking for disposal.

8.2 Wear and Tear

Invacare reserves the right to ask for any item back that has an alleged defect in workmanship. See Warranty that shipped with the product for specific warranty information.

Refer to the this user manual for proper preventative maintenance schedule and use of the product.

This is just a general guideline and does not include items damaged due to abuse and misuse.

Normal wear and tear items and components for this product are listed below.

- All types of filters
- All types of tubing



Sieve is a porous filtering material and is considered a wear item. Some factors that could affect sieve material life include humidity, temperature, particulates, air contaminants, air intake, vibration and other environmental conditions.

9 Troubleshooting

9.1 Troubleshooting

SYMPTOM	PROBABLE CAUSE	SOLUTION
<p>Alarm:</p> <p>No lights illuminated.</p> <p>Short Beeps, long pause</p> <p>Concentrator not operating, power switch On.</p> <p>Beep...Beep...</p>	<p>Main Power Loss:</p> <ol style="list-style-type: none"> 1. Power cord not plugged in. 2. No power at outlet. 3. Tripped circuit breaker. 	<ol style="list-style-type: none"> 1. Insert plug into outlet. 2. Inspect house circuit breakers or fuses. If problem recurs, use a different outlet. 3. Push/reset circuit breaker. If problem recurs, call service provider.
<p>Alarm:</p> <p>RED light illuminated.</p> <p>Continuous on.</p> <p>Concentrator not operating, power switch On.</p> <p>Beep...</p>	<p>System Failure:</p> <ol style="list-style-type: none"> 1. Unit overheating due to blocked air intake. 2. Insufficient power at outlet. 3. Internal repairs required. 	<ol style="list-style-type: none"> 1. Do one or both of the following: <ol style="list-style-type: none"> a. Remove and clean cabinet filters. b. Move oxygen concentrator at least 12 in (30, 5 cm) away from walls, draperies or furniture. 2. DO NOT use extension cords. Move to another electrical outlet or circuit. 3. Call service provider.
<p>Alarm:</p> <p>GREEN light illuminated.</p> <p>Rapid</p> <p>Beep...Beep...</p> <p>Beep...Beep</p>	<p>Potential Obstruction Alert</p> <ol style="list-style-type: none"> 1. Possible internal obstruction in the oxygen path. Kinked or blocked tubing, cannula or humidifier. 2. Flowmeter set at 1.0L/min or less. 	<ol style="list-style-type: none"> 1. Inspect for kinks or blockages. Correct, clean or replace item. Once corrected, turn power Off for 60 seconds and then turn power back ON. 2. Reset flowmeter to prescribed flowrate.

10 Technical data

10.1 Specifications

Electrical Requirements:	120 VAC + 10, -15% (132 VAC/102 VAC), 60 Hz
Rated Current Input:	4.9 A
Sound Pressure Level:	<p>≤ 62 dBA weighted for 3 L/min flow</p> <p>≤ 62 dBA weighted for 10 L/min Flow</p>
Sound Power Level:	≤ 62 dBA weighted for 10 L/min flow
Altitude:	<p>Up to 4,000 ft (1230 m) above sea level without degradation of concentration levels.</p> <p>Atmospheric Pressure Range: 101.33 kPa – 88.0 kPa</p>
Oxygen Output Concentration Levels:	<p>87% to 95.6% at 2 L to 10 L/min</p> <p> Concentration levels achieved after initial warm-up period (approximately 30 minutes)</p>
Maximum Outlet Pressure:	9 psi ± 0.5 psi (62.0 kPa ± 3.45 kPa)
Flow Range:	2 L to 10 L/min
Potential Obstruction Alert:	The concentrator detects a condition that may indicate a potential obstruction of the output oxygen. Rapid audible beeping alert (this alert is deactivated when accessories are connected). May be associated with flow setting of 1 L/min or less.
Power Consumption:	585 W Typical
Pressure Relief Mechanism Operational at:	35 psi ± 5 psi (241 kPa ± 34.5 kPa)
Change in maximum recommended flow when back pressure of 7 kPa is applied:	0.7 L/min

Filters:	Cabinet (2), Outlet HEPA and Compressor Inlet
Safety System:	Current overload or line surge shutdown. High temperature compressor shutdown. High Pressure Alarm w/compressor shutdown. Low Pressure Alarm w/compressor shutdown. Battery Free Power Loss Alarm.
Width:	18 3/8 in ± 3/8 in (46.7 cm ± 1 cm)
Height:	26 3/8 in ± 3/8 in (67.0 cm ± 1 cm)
Depth:	14 3/8 in ± 3/8 in (36.5 cm ± 1 cm)
Weight:	53 lbs ± 2 lbs (24.0 kg ± 1 kg)
Shipping Weight:	60 lbs ± 2 lbs (27.2 kg ± 1 kg)
Operating Ambient Temperature and Humidity:	50°F to 95°F (10°C to 35°C) at up to 60% relative humidity
Cabinet:	Impact Resistant flame-retardant plastic cabinet that conforms to UL 94V-0
Standards and Regulatory Listing:	Double Insulated Product ETL certified complying with UL 1097 ETL certified to CSA C22.2 No. 68.
Electrical:	No extension cords
Placement:	No closer than 12 in (30.5 cm) from any wall, furniture, draperies or similar surfaces to assure sufficient air flow. Avoid deep pile carpets and heaters, radiators or hot air registers. Floor location only. No confined spaces (Example: No closets).

Tubing:	7 ft (2.1 m) cannula with a maximum 50 ft (15 m) of Crush-Proof Tubing (DO NOT pinch)
Time of Operation:	Up to 24 hours per day
Recommended Storage and Shipping Temperature:	-20° F to 150° F (-29° C to 65° C) at up to 95% relative humidity



Measurement uncertainty is included in the device specification. All conditions at ATPD.

II Warranty

II.1 North American Limited Warranty



THE WARRANTY BELOW HAS BEEN DRAFTED TO COMPLY WITH FEDERAL LAW APPLICABLE TO PRODUCTS MANUFACTURED AFTER JULY 4, 1975.

This warranty is extended only to the original purchaser who purchases this product when new and unused from Invacare Corporation or a dealer. This warranty is not extended to any other person or entity and is not transferable or assignable to any subsequent purchaser or owner. Coverage under this warranty will end upon any such subsequent sale or other transfer of title to any other person. This warranty gives you specific legal rights and you may also have other legal rights which may vary from state to state.

Invacare Corporation warrants its Platinum 10 Oxygen Concentrators when purchased new and unused to be free from defects in materials and workmanship for a period of three years from date of purchase from Invacare or a dealer, with a copy of the seller's invoice required for coverage under this warranty.

DO NOT OPEN OR ATTEMPT TO SERVICE THE 4-WAY VALVE BODY.

This will void any and all warranty applicable to the valve body. If within such warranty periods any such product shall be proven to Invacare Corporation's satisfaction to be defective, such product shall be repaired or replaced, at Invacare Corporation's option. This warranty only applies to the labor for repairs performed by the Invacare Service Department or Invacare Authorized Service Centers. It does not apply to the labor performed by the purchaser or user. This warranty does not include normal wear and tear or shipping charges. Invacare Corporation's sole obligation and your

exclusive remedy under this warranty shall be limited to such repair or replacement.

Routine maintenance items, such as filters, are excluded from this warranty. For warranty service, please contact Invacare Corporation's Service Department at the toll free number on the back cover. Upon receiving notice of an alleged defect in a product, Invacare Corporation will issue a serialized return authorization. It shall then be the responsibility of the purchaser to return the entire unit or remove, at purchaser's cost, the defective component part(s) identified, pack the component part(s) in a manner to avoid shipping damage and to ship the component part(s) to either Invacare Corporation's plant or service center as specified by Invacare Corporation in advance. Defective component part(s) must be returned for warranty inspection using the serial number as identification within thirty days of return authorization date. Do not return products to our factory without prior consent. C.O.D. shipments will be refused; please prepay shipping charges.

LIMITATIONS AND EXCLUSIONS: THE FOREGOING WARRANTY SHALL NOT APPLY TO PRODUCTS SUBJECTED TO NEGLIGENCE, ACCIDENT, IMPROPER OPERATION, MAINTENANCE OR STORAGE, SOOT OR SMOKE-FILLED ENVIRONMENTS, OR OTHER THAN NORMAL APPLICATION, USE OR SERVICE, OR TO PRODUCTS MODIFIED WITHOUT INVACARE CORPORATION'S EXPRESS WRITTEN CONSENT (INCLUDING, BUT NOT LIMITED TO, MODIFICATION THROUGH THE USE OF UNAUTHORIZED PARTS OR ATTACHMENTS) OR TO PRODUCTS DAMAGED BY REASON OF REPAIRS MADE TO ANY COMPONENT WITHOUT THE SPECIFIC CONSENT OF INVACARE CORPORATION OR TO PRODUCTS DAMAGED BY CIRCUMSTANCES BEYOND INVACARE CORPORATION'S CONTROL.

THE FOREGOING EXPRESS WARRANTY IS EXCLUSIVE AND IN LIEU OF ANY OTHER WARRANTIES WHATSOEVER, WHETHER EXPRESS OR IMPLIED, INCLUDING THE IMPLIED WARRANTIES OF MERCHANTABILITY AND FITNESS FOR A PARTICULAR PURPOSE, AND THE SOLE REMEDY FOR VIOLATIONS OF ANY WARRANTY WHATSOEVER, SHALL BE LIMITED TO REPAIR OR REPLACEMENT OF THE DEFECTIVE PRODUCT PURSUANT TO THE TERMS CONTAINED HEREIN. THE APPLICATION OF ANY IMPLIED WARRANTY WHATSOEVER SHALL NOT EXTEND BEYOND THE DURATION OF THE EXPRESS WARRANTY PROVIDED HEREIN. INVACARE SHALL NOT BE LIABLE FOR ANY CONSEQUENTIAL OR INCIDENTAL DAMAGES WHATSOEVER.

SOME STATES DO NOT ALLOW THE EXCLUSION OR LIMITATION OF INCIDENTAL OR CONSEQUENTIAL DAMAGE, OR LIMITATION OF HOW LONG AN IMPLIED WARRANTY LASTS, SO THE ABOVE EXCLUSION AND LIMITATION MAY NOT APPLY TO YOU. THIS WARRANTY SHALL BE EXTENDED TO COMPLY WITH STATE/PROVINCIAL LAWS AND REQUIREMENTS.

Notes

Notes

Invacare Corporation

USA

One Invacare Way
Elyria, Ohio USA
44035
Tel: 440-329-6000
Tel: 800-832-4707
Technical Services
Tel: 440-329-6593
Tel: 800-832-4707
www.invacare.com



1118353-M-00 2016-08-01



Manufacturer

Invacare Corporation
2101 E. Lake Mary Blvd.
Sanford, FL 32773
Tel: 407-321-5630

Making Life's Experiences Possible™



Yes, you can.®