

INSTRUCTIONS FOR USE

Sara Flex



WARNING

To avoid injury, always read this *Instructions for Use* and accompanied documents before using the product.



Mandatory to read the *Instructions for Use*.

Design Policy and Copyright

® and ™ are trademarks belonging to the Arjo group of companies.

© Arjo 2020.

As our policy is one of continuous improvement, we reserve the right to modify designs without prior notice. The content of this publication may not be copied either whole or in part without the consent of Arjo.

Content

Content	3
Foreword	4
Intended Use	5
Safety Instructions	6
Preparations	7
Sara Flex Directions	7
Parts Designation	8
Product Description / Functions.....	9
Controls and Features	9
LCD Display	10
Castor Brakes	10
Emergency Stop Button	11
Power Button	11
Leg Support	11
Leg Strap	11
Leg Strap attachment (optional).....	12
Emergency Lowering	13
Allowed Slings with Sara Flex	14
Central Hook (Accessory)	14
Transfer from Wheelchair to Sara Flex	15
Prepare Sara Flex and Patient	15
Place Patient in Sara Flex	15
Raise a Patient to Standing Position.....	17
Patient Transfer.....	17
Transfer from Sara Flex to Toilet.....	18
Transfer from Sara Flex to Bed/Chair	19
Scale (Optional).....	20
Using the Scale - Weigh the Patient.....	22
Method A - Weigh the Patient without Sling Weight.....	22
Method B - Weigh Patient with Sling	23
Changing the Units of Measure	24
Battery Instructions.....	25
Cleaning and Disinfection Instructions	27
Troubleshooting.....	29
Care and Preventive Maintenance	30
Technical Specifications	34
Dimensions.....	36
Labels on Sara Flex	37
List of Standards and Certificates.....	39
Electromagnetic Compatibility	40
Parts and Accessories	42

Foreword

Thank you for purchasing Arjo equipment.

Please contact us if you have any questions about the operation or maintenance of your Arjo equipment.

Please read and fully understand these *Instructions for Use (IFU)* before using *Sara Flex*.

If a serious incident occurs in relation to this medical device, affecting the user, or the patient then the user or patient should report the serious incident to the medical device manufacturer or the distributor. In the European Union, the user should also report the serious incident to the Competent Authority in the member state where they are located.

Information in this *IFU* is necessary to perform the operation and maintenance of the equipment. It will help to protect your product and make sure that the equipment performs to your satisfaction. The information in this *IFU* is important for the safety of both patient and caregiver and must be read and understood to help prevent possible injury.

Unauthorized modifications on any Arjo equipment can affect safety. Arjo will not be held responsible for any accidents, incidents or lack of performance that occur as a result of any unauthorized modification to its products.

Serious incident

If a serious incident occurs in relation to this medical device, affecting the user, or the patient then the user or patient should report the serious incident to the medical device manufacturer or the distributor. In the European Union, the user should also report the serious incident to the Competent Authority in the member state where they are located.

Service and Support

Routine maintenance must be performed on *Sara Flex* to maintain safety and reliability of the equipment. See section “*Care and Preventive Maintenance*” on page 30.

If further information is needed, contact your local Arjo representative for replacement parts. The contact information appear on the last page of this *IFU*.

Definitions in this *IFU*

WARNING

Means: Safety warning. Failure to understand and obey this warning may result in injury to you or to others.

CAUTION

Means: Failure to follow these instructions may cause damage to all or parts of the system or equipment.

NOTE

Means: This is important information for the correct use of this system or equipment.



Means: The name and address of the manufacturer.

Intended Use

This equipment must be used in accordance with these safety instructions. Anyone using this equipment must also have read and understood the instructions in these IFU.

If there is anything that remains unclear, contact your Arjo representative.

Intended Use for *Sara Flex*

Sara Flex is a mobile standing and raising aid, with a Safe Working Load of 200kg (440 lb), intended to assist caregivers in hospitals, long-term care, nursing homes and home care environments, including private homes, to lift and transfer patients/residents from one place to another e.g. to and/or from a chair, wheelchair, bed side, bath, shower/commode chair or toilet.

The equipment must be used by appropriately trained caregivers with adequate knowledge of the care environment, its common practice and procedures and according to guidelines in this *IFU*.

Sara Flex should only be used for the purpose specified in this *IFU*. Any other use is prohibited.

Patient/Resident Assessment

It is recommended that facilities establish regular assessment routines to make sure that caregivers are assessing each patients/residents prior to use.

Before use the caregiver should always consider the patients/residents medical condition, physical and mental capabilities.

In addition the patient/resident must

- be able to bear weight on at least one leg and have some trunk stability
- be able to sit on the edge of the bed
- weigh in the range of 45 to 200 kg (99 lb – 440 lb)
- have a height within the range of 145 to 195 cm (4'8" – 6'4").

If the patient does not meet these criteria an alternative equipment/system shall be used.

CAUTION

To avoid product damage do not use *Sara Flex* outdoors. The product is intended to be used with specifically designed slings.

Expected Service Life

The expected service life is the maximum period of useful life as defined by the manufacturer.

The expected service life for *Sara Flex* is ten (10) years considering the product has been serviced and maintained as indicated in the Care and Preventive Maintenance section.

Actual service life may vary depending on the frequency of use and conditions.

The *IFU* shall be available as long as reasonably necessary, taking the lifetime of the device into consideration.

Other consumable parts, e.g. batteries, sling, etc. are also subject to wear and their expected operational life is dependent on usage.

Safety Instructions

WARNING

To avoid injury, make sure that the patient is not left unattended at any time.

WARNING

This equipment includes small parts that may present a choking hazard to small children if inhaled or swallowed.

Keep children and pets away from the equipment.

The hand control cable presents a strangulation risk; take all precautions necessary to prevent this.

WARNING

To avoid injury, a full clinical assessment of the patient's condition, and suitability must be carried out by qualified personnel, before attempting to use *Sara Flex*.

WARNING

To avoid injury, make sure that the applied load is lower than the safe working load for all products or accessories being used.

CAUTION

To avoid corrosion on the product do not leave *Sara Flex* and its accessories for extended periods in humid or wet areas.

Policy on Number of Staff Members Required for Patient Transfer

Arjo's floor lifts are designed for safe usage with one caregiver. It is the responsibility of the caregiver to determine if a one or two person transfer is more appropriate, based on the following:

- patient's condition
- the task
- patient's weight
- environment
- capability
- skill level of the caregiver

Do not hesitate to contact your medical professional for guidance.

Preparations

Actions Before First Use (6 steps)

1. Visually check the package for damage. If the product looks damaged due to freight, contact the transport agency.
Do NOT use the product.
2. The packaging should be recycled according to local regulations.
3. Read this *IFU*.
4. Choose a designated area, where this *IFU* should be kept and is easily accessible at all times.
5. Verify each functions (Up-Down, Open-Close lift legs)
6. Initiate the emergency lowering function to check it is working correctly. To do this, pull up the red emergency lowering handle and keep it pulled up, whilst at the same time, push down on the lifting arm until it starts lowering.

NOTE

Initial activation may require additional amount of load on the lifting arm. It may be helpful if two people perform this check, one to activate the handle and the other to push down the lift arm.

Actions Before Every Use (2 steps)

1. Visually inspect *Sara Flex*. If any part is damaged - do NOT use the product.
2. Check the battery level.

In between Use

Clean and disinfect the product according to section “*Cleaning and Disinfection Instructions*” on page 27.

Sara Flex Directions

Left and right

Sara Flex has a left and right side. (See Fig. 1)

Transfer direction

The caregiver must be positioned behind *Sara Flex* during transfer.

Fig. 1

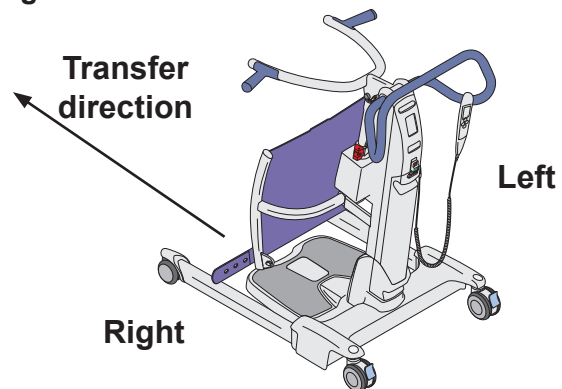

Parts Designation

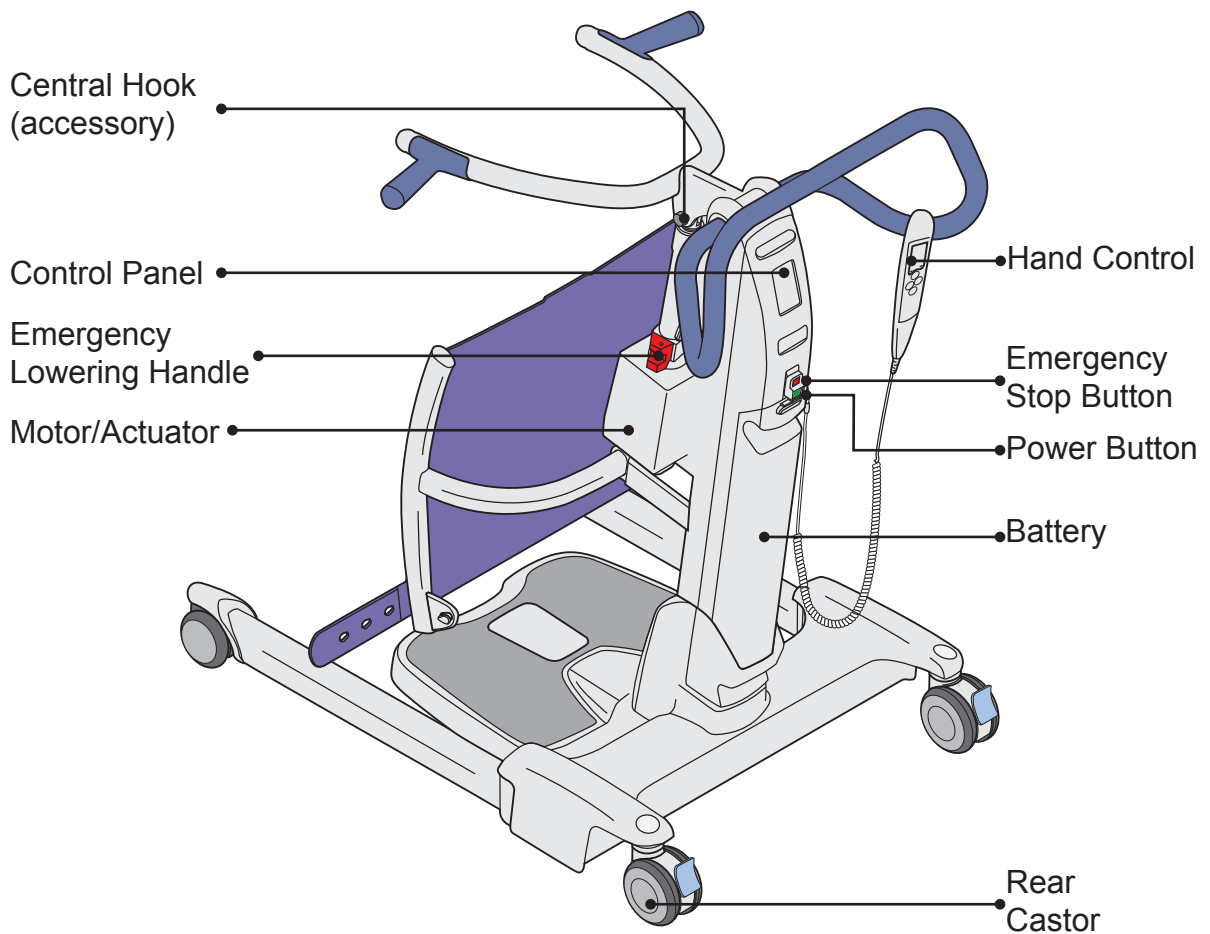
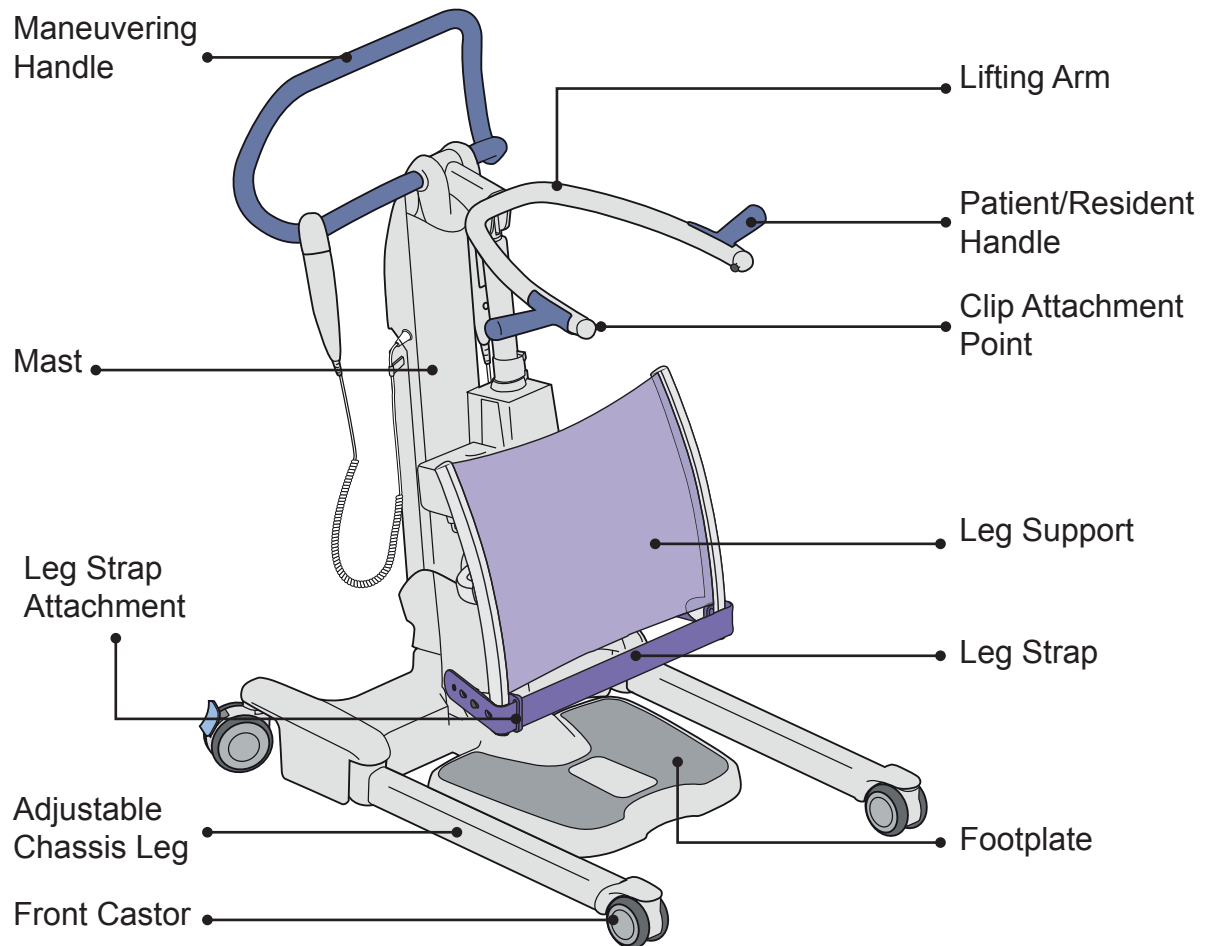

Product Description / Functions

Fig. 2

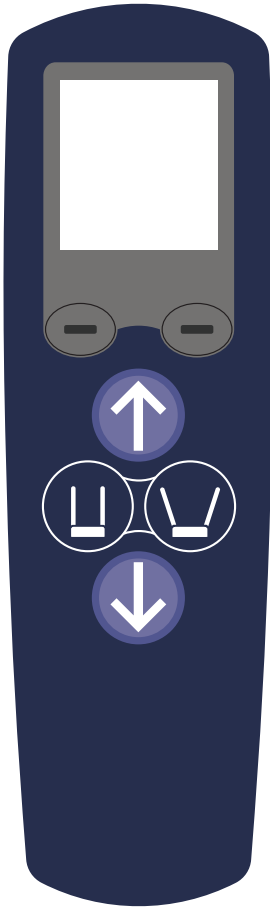





Controls and Features

Hand control (See Fig. 2)

Use the hand control to:

- Raise/lower the lifting arm on *Sara Flex*.
- Open/close the chassis legs on *Sara Flex*.
- The dash buttons are used for menu operations.

Button Functions:

-  Up
-  Down
-  Close lift legs
-  Open lift legs
-  Right Dash
-  Left Dash

If a pressed button is released, it will stop its function immediately.

Fig. 3

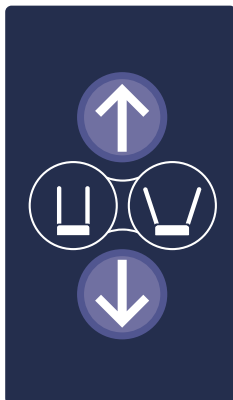

Control Panel (See Fig. 3)

The mast-mounted control panel operates in parallel with the hand control. *Sara Flex* can also be controlled from the mast.

Button Functions:



-  Up
-  Down
-  Close lift legs
-  Open lift legs

Fig. 4



LCD Display

(See Fig. 4)



Battery Level - see “*Battery Instructions*” on page 25.

0.0

Usage counter



Maintenance symbol

0.0

Patient's weight - see “*Scale (Optional)*” on page 20.

At start up it takes a little time before the display looks as shown in **Fig. 4**. The LCD display will only light up when a button is pressed.

Usage counter

The usage counter shows the total added amount of time (in hours) that the lift's lifting arm has been raised or lowered.

The usage counter will increase in increments of 0.1 hours whenever an additional six minutes have been added.

NOTE
The usage counter only records during movement of the lifting arm.

Maintenance symbol

The maintenance symbol is a reminder for the yearly maintenance requirements for the product.

The maintenance symbol is shown after a 125 hours of usage. This is the average time a lift is used during one year. the maintenance symbol will flash (1 sec ON and 1 sec OFF).

When the maintenance symbol appears, the unit will still be safe to use, but the yearly maintenance should be performed as soon as possible.

NOTE
The technician must reset the display to “0.0” hours when the annual inspection is performed. This is done to visually see when next inspection is due.

Fig. 5

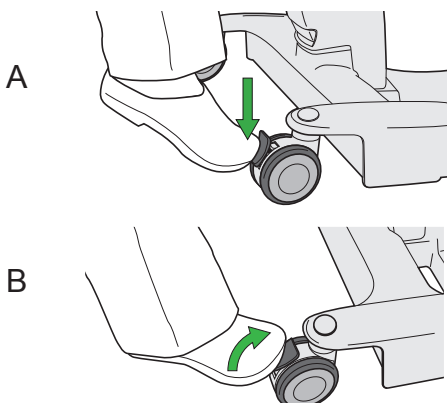

Castor Brakes

The rear castors brakes are foot operated to keep *Sara Flex* in position.

Apply the brakes (See Fig. 5):

Press down on the gray castor brake lever (A).

Release the brakes (See Fig. 5):

Slightly kick up the gray castor brake lever (B).

Fig. 6

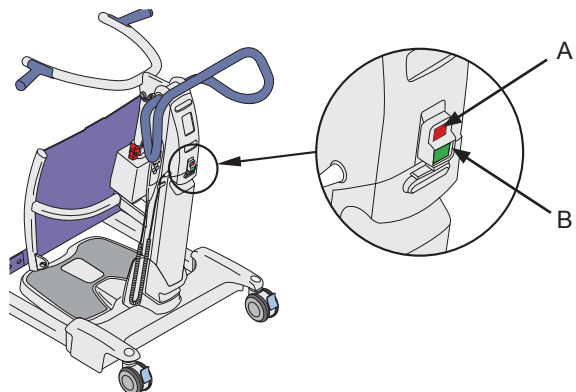

Emergency Stop Button

To Activate

Press the red emergency stop button (A) to cut all power to all electrical components. (See Fig. 6)

To Deactivate

Press the green power button (B) to power on the equipment again. (See Fig. 6)

Power Button

The green power button (B) is located next to the stop button. Press the power button to switch on *Sara Flex*. (See Fig. 6)

Fig. 7

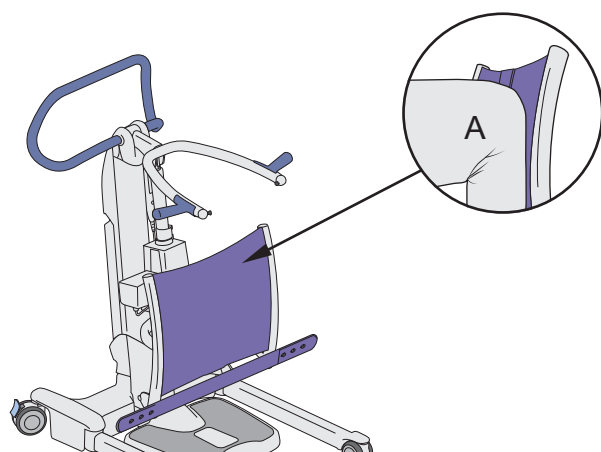

Leg Support

The leg support is made out of silicone. (See Fig. 7)

This material adjusts itself based on the pressure applied by the patient knees (A).

Fig. 8

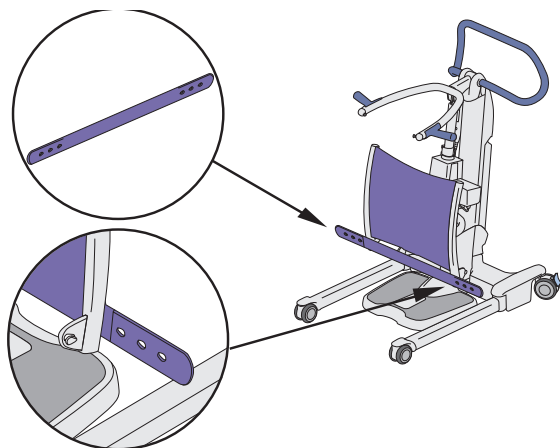

Leg Strap

The leg strap is located under the silicone leg support. (See Fig. 8)

The leg strap is used to make sure that the patient's legs stay close to the leg support.

To fasten the leg strap attach it to the attachment point on either side of the leg support.

Leg Strap attachment (optional)

Fig. 9

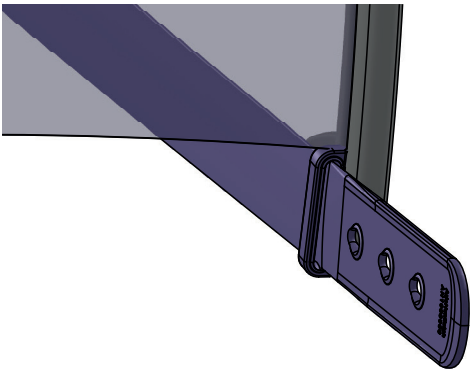

Insert strap from the leg strap attachment.
(See Fig. 9)

Fig. 10

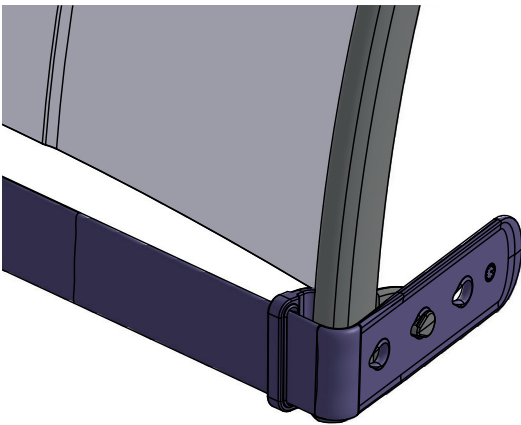

Fasten strap to the leg pad support.
(See Fig. 10)

Fig. 11

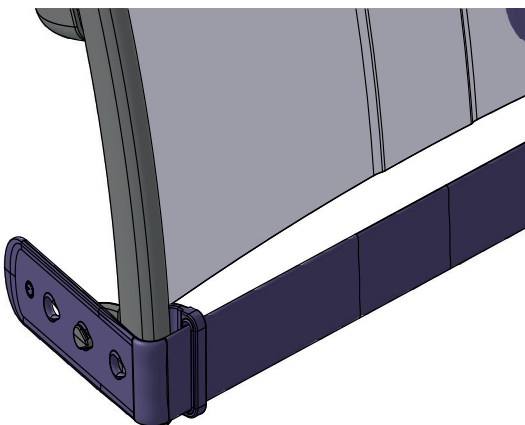

Repeat on the other side, if needed.
(See Fig. 11)

Fig. 12



Emergency Lowering

In the event that the emergency lowering function needs to be activated, position the Sara Flex so that the patient can be lowered on to an appropriate surface such as a chair or bed. Stand near of the Sara Flex, on the same side as the red emergency lowering handle. **(See Fig. 12)**

Fig. 13

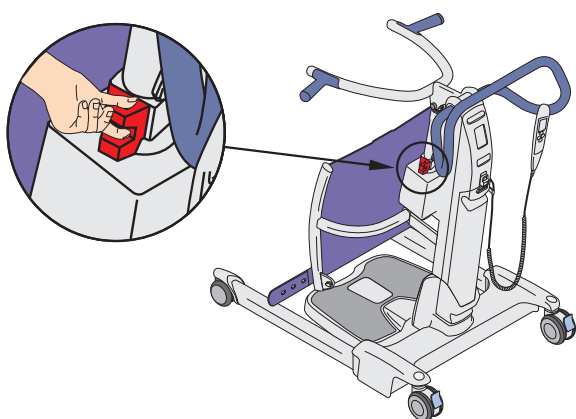

Use one hand to gradually pull up the emergency lowering handle (and keep it there) allowing the lifting arm to lower the patient onto the surface. Once lowered, let go of the emergency lowering handle and it will return to its correct position. **(See Fig. 13)**

NOTE

If the lifting arm does not start to lower when the emergency lowering handle is pulled up, use your other hand to push down on the lifting arm whilst still pulling up on the emergency lowering handle, until the lifting arm begins to lower. (If the lifting arm is in the fully upright position, it may help to stand facing the patient and push the lifting arm away from you). Keep the emergency lowering handle pulled up fully until the patient is lowered on to the receiving surface.

Automatic Cut-Out

This is not an operator control but a function built into the *Sara Flex* electronics.

If the lift is inadvertently overloaded by trying to raise or lower a load heavier than permitted, an automatic “cut-out” function operates to prevent the lift from raising a weight in excess of the safe working load (SWL). This will stop the lift’s motion automatically.

If this occurs, release the “up” button on the hand control or the control panel. Do not continue to raise the load. Make sure that the *Sara Flex* operates only within its safe working load.

Anti-Crush System

This is not an operator control but a function built into the *Sara Flex* electronics.

Great care should be taken not to lower the lifting arm onto the patient or any other obstruction. If this should happen, the *Sara Flex* “anti-crush” system will engage, stop the motor and all downward movement will cease. If this occurs, release the “down” button immediately and press the “up” button to raise the lifting arm until the lift is clear.

Then remove the obstruction.

Allowed Slings with *Sara Flex*

The following slings are compatible with *Sara Flex*.

Active Slings (See Fig. 14)

- TSS.500 (S)
- TSS.501 (M)
- TSS.502 (L)
- TSS.503 (XL)
- TSS.504 (XXL)

Flites

- MFA3000 (Flite)

Transfer Sling (See Fig. 15)

- TSS.511 (Transfer Sling Model, only to be used with Central Hook)

For sling selections see respective sling *IFU*.

Fig. 14

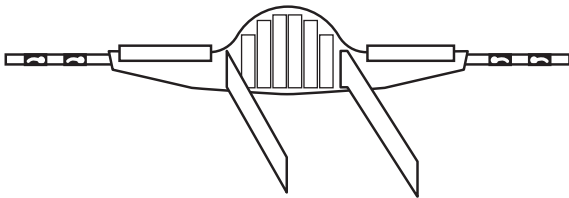

Fig. 15

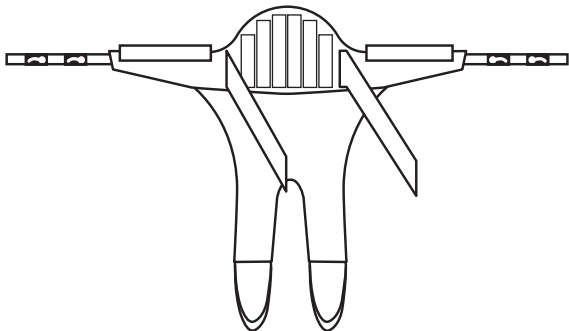
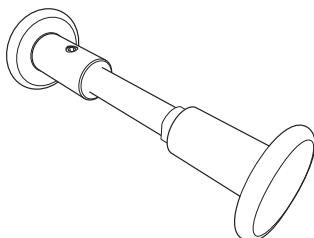

Fig. 16



Central Hook (Accessory)

Only to be used with the transfer sling. The central hook (See Fig. 16) is to be installed right under the lifting arm by qualified personnel only.

Transfer from Wheelchair to *Sara Flex*

Prepare *Sara Flex* and Patient

- For sling instructions, see respective sling *IFU* and the sling label.
- Determine if *Sara Flex* is the appropriate equipment to use for the patient, see “*Intended Use*” on page 5.
- Lower the *Sara Flex* lifting arm to its lowest position.
- Inform the patient about the transfer (e.g. transfer to bathroom).
- Select and apply sling, see respective sling *IFU*.
- Apply brakes to the wheelchair (if applicable).

Place Patient in *Sara Flex*

(8 Steps)

1. Open chassis legs if needed to accommodate the width of the chair, bed, etc.

NOTE

If the chassis legs can fit underneath the furniture, do not open the chassis legs

2. Ask or assist the patient to place his/her feet on the foot plate. (See Fig. 17)

Fig. 17

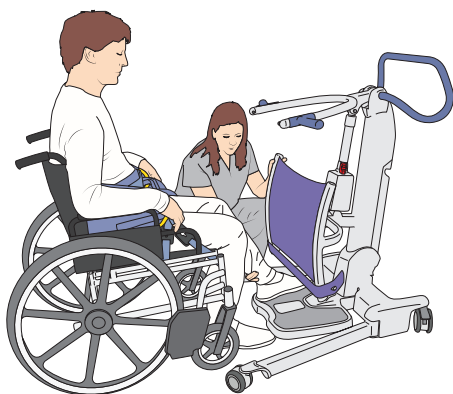
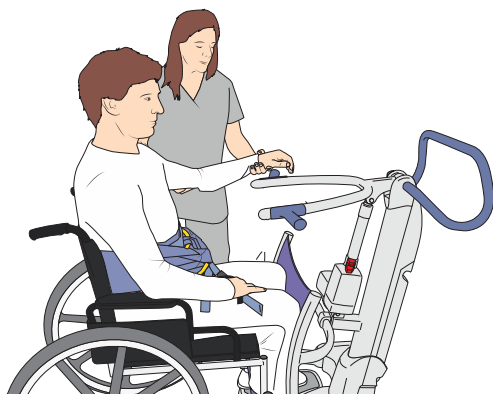

Fig. 18



3. Push *Sara Flex* towards the patient until it gently touches the patient's shins. (See Fig. 18)

Fig. 19



4. Ask or assist patient to place his/her hands on the patient/resident handles. (See Fig. 19)

Fig. 20

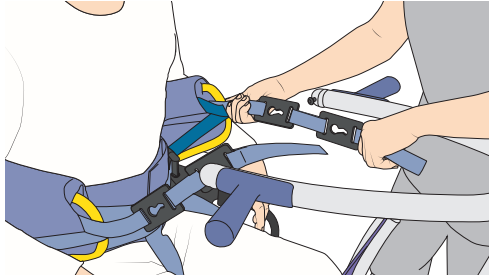

5. Attach sling clips to attachment points on the Sara Flex lifting arm. (See Fig. 20)

Fig. 21

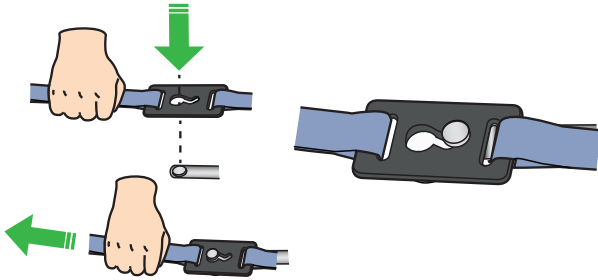

6. Make sure the clips are attached securely. (See Fig. 21)

Fig. 22

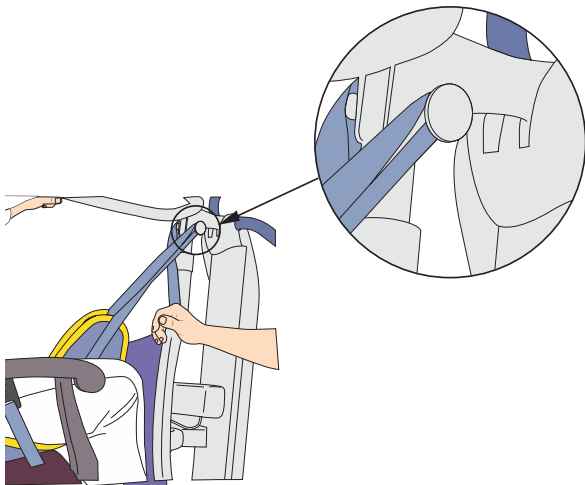

7. When using a transfer sling, also attach the loops on the central hook (accessory) located right under the lifting arm. (See Fig. 22)

Fig. 23

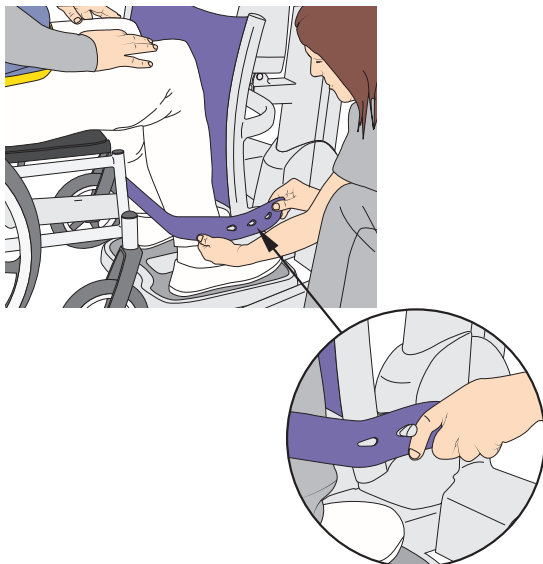

8. Attach the leg strap to support the patient's legs, if needed. (See Fig. 23)

Fig. 24



Fig. 25



Raise a Patient to Standing Position

NOTE

- When raising the patient with transfer sling, he/she should not help out while being raised.
- When using the transfer sling, do not raise the patient higher than seating position. A higher position will not be comfortable for the patient.

(5 Steps)

1. Stand next to the patient and inform him/her that the *Sara Flex* will be raised to a standing position.
2. Check attachment points to make sure the *Sara Flex* is ready.

WARNING

To avoid injury make sure the patient is participating. If not, consider to end the transfer, return the patient to a sitting position and reevaluate the choice of equipment.

3. Use the hand control to raise patient from sitting position to standing position. (See Fig. 24)
4. While the patient is standing, check the supports.
5. Tighten safety straps around the abdomen, if needed.

Patient Transfer

(2 Steps) (See Fig. 25)

1. Pull *Sara Flex* away from the wheelchair, using the maneuvering handle.
2. Close the chassis legs if needed.

Transfer from Sara Flex to Toilet

Fig. 26



Fig. 27

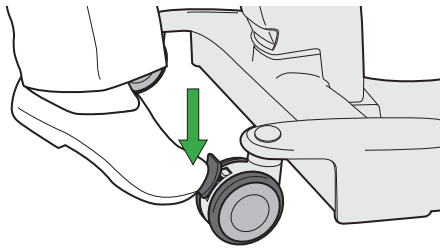

(18 Steps)

1. Using the maneuvering handle, position patient in front of the toilet/commode or device that patient will sit on. **(See Fig. 26)**
2. Adjust chassis legs if needed.
3. While the patient is standing caregiver can help with the patient's clothing (i.e., dressing, undressing or toileting tasks etc.).
4. Position the patient over the toilet/commode. Press the down arrow on the hand control to lower the patient to a sitting position.
5. Stand next to the patient while he/she is being lowered.

WARNING

To avoid pinching of genitals and skin, make sure there is enough clearance during movement .

6. Apply the castor brakes to keep *Sara Flex* in position once the patient is sitting on the toilet. **(See Fig. 27)**
7. Remove sling clips from *Sara Flex*.
8. Have the patient release their hands from the patient/resident handles.
9. Detach leg straps, if applicable.
10. Remove sling, if needed.
11. Allow privacy for the patient, but make sure the patient is not left unattended.
12. After providing personal hygiene care, reapply sling, if removed.
13. Ask or assist patient to place his/her hands on the patient/resident handles. **(See Fig. 19)**
14. Attach sling clips to attachment points on the *Sara Flex* lifting arm. **(See Fig. 20)**
15. Make sure the clips are attached securely. **(See Fig. 21)**
16. Raise the patient slightly and apply any necessary incontinent products and adjust clothing.
17. Release the brakes.
18. Before transfer from the toilet, repeat the steps in "*Raise a Patient to Standing Position*" on page 17.

Transfer from Sara Flex to Bed/Chair

Fig. 28



Fig. 29

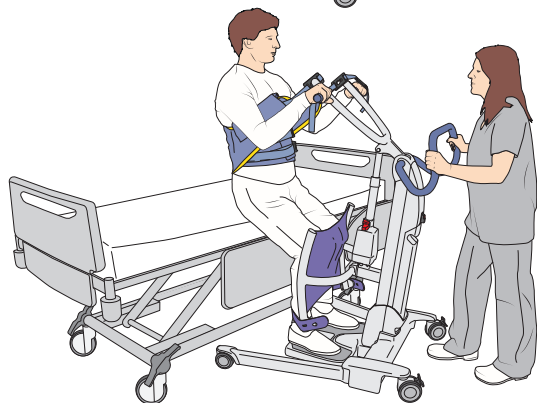

(11 Steps)

1. Apply the brakes on the wheelchair, if applicable.
2. Adjust chasis legs if needed to go around bed/ chair. (See Fig. 28)
3. Lower the patient onto the surface of bed/ chair. (See Fig. 29)
4. Make sure the patient is positioned correctly on the bed/ chair.
5. Detach the sling from *Sara Flex*.
6. Have the patient release their hands from patient/ resident handles.
7. Detach leg straps, if applicable.
8. Have the patient lift his/her feet off the footplate, assist if needed.
9. Pull the *Sara Flex* away from the patient.
10. Remove the sling from the patient
11. Clean the *Sara Flex* after the transfer is complete, according to “*Cleaning and Disinfection Instructions*” on page 27 or according to local guidelines.

Scale (Optional)

WARNING

To avoid injury, only use the scale to weigh hospital or care facility patients under the supervision of Nursing staff and healthcare professionals.

CAUTION

The unit must be stationary on a flat level surface when it is powered up, to allow the scale to perform an automatic zero reset.

Do not touch the lift or any of its components until the scale displays “0.0”. Failure to do so may result in inaccurate reading of the weight on the scale.

Display Symbols/Functions

The LCD screen on the hand control can display weight in kilograms (kg) (or pounds (lb) in specific markets).

The minus sign (-) appears when the weight is negative (see “*Method B - Weigh Patient with Sling*” on page 23”).

Fig. 30



Scale Symbol

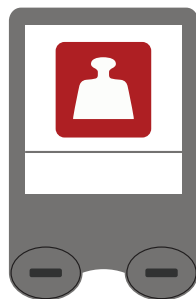

Maximum Weight Warning Symbol

Overload Warning Symbol

The maximum weight warning symbol appears when the patient weight exceeds the Safe Working Load (SWL) 200 kg (440 lb). (See Fig. 30)

If the scale is overloaded, the unit will beep 2 times and the display will switch between the scale symbol and the maximum weight warning symbol. Remove the overload weight by lowering the patient immediately.

Do not touch the scale/lift until the symbol is switched off.

Fig. 31



Net weight

This is the Net weight of the patient without any accessories e.g. sling. (See Fig. 31)

For instruction on how to get the Net weight of the patient, see “Method A - Weigh the Patient without Sling Weight” on page 22

Fig. 32

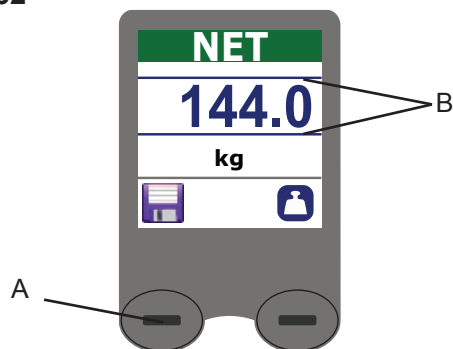

Save weight

To use the Save function, press the left dash button (A), to store the weight on the scale. (See Fig. 32)

This will save the displayed measurement on the screen. Two blue lines will be displayed when the displayed measurement is saved (B).

NOTE

Patient should be as still as possible during the weighing procedure. Too much movement by the patient may cause an incorrect reading

Fig. 33

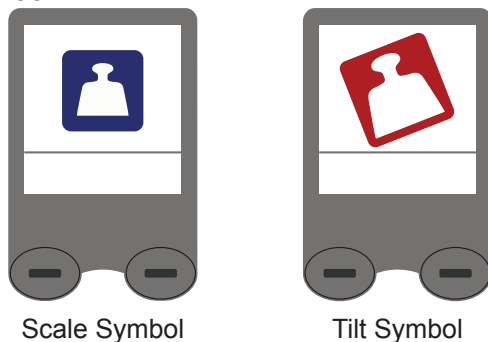

Tilt (for class III scale only)

The display will switch between the scale symbol with a tilted symbol.

NOTE

FOR CLASS III SCALE ONLY,
If the display shows the larger “TILT” symbol alternating with the scale symbol, relocate *Sara Flex* to a level position so that the scale can be operated correctly (See Fig. 29).

When the *Sara Flex* is tilted, no weight reading will be available.

It is normal that the display occasionally shows a “Tilt” symbol when the lift is being moved or touched.

Using the Scale - Weigh the Patient

Fig. 34

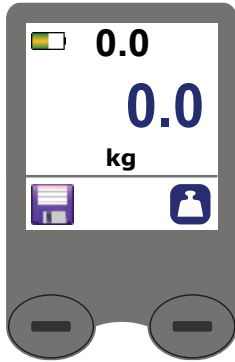

Fig. 35



Fig. 36



Fig. 37

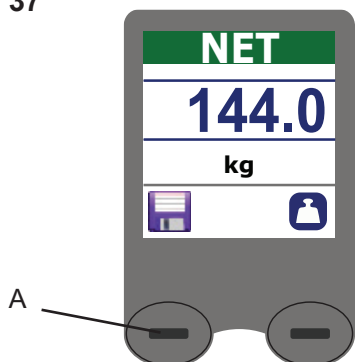

Method A - Weigh the Patient without Sling Weight

(8 Steps)

1. Use the power button to power on the *Sara Flex*.
2. If the sling is already installed on the *Sara Flex* it has already zeroed the scale weight automatically. **(See Fig. 34)**
Move ahead to step 5.
3. If the sling isn't already installed on the lift, install the sling. The scale will now show the weight of the sling on the screen.
4. To use the Scale function, press the right dash button (A) to zero the scale. Now the display will show a zero weight with a NET symbol. **(See Fig. 35)**
5. Apply the sling on the patient, see respective Sling *IFU*. Place the patient safely onto *Sara Flex*.

6. Lift the patient. **(See Fig. 36)**

7. The net weight of the patient is now displayed. **(See Fig. 37)**
8. Press the left dash button (A) to keep the Net weight text on the display.

NOTE

When the *Sara Flex* goes into sleep mode the weight text on the display will disappear.

Method B - Weigh Patient with Sling

(7 Steps)

1. Raise the patient to a standing position.
2. Press the right dash button to obtain a zero reading on the display. (See Fig. 38)
3. Complete the patient transfer and remove him/her from the *Sara Flex*.
4. The scale will display a negative number.
5. Attach the sling back on *Sara Flex*.
6. Ignore the minus sign on the screen. Allow the weight reading to stabilize. The weight shown is the patient's actual weight. (See Fig. 39)
7. Press the left dash button (A) to save the net weight text on the display.

Fig. 38



Fig. 39

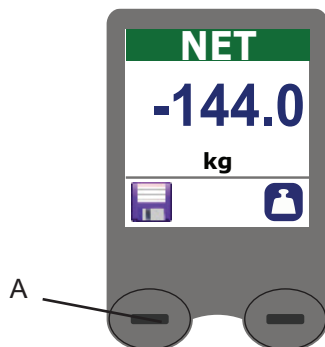

NOTE

When the *Sara Flex* goes into sleep mode the weight text on the display will disappear.

Fig. 40

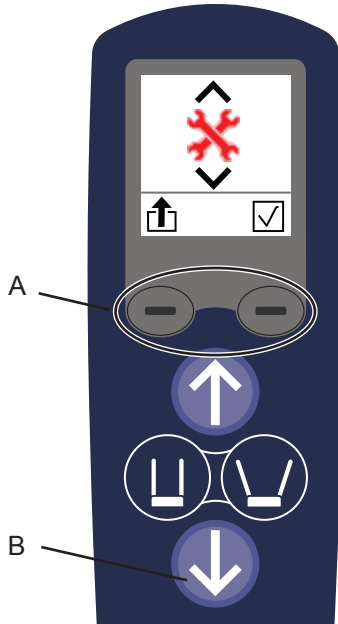

Changing the Units of Measure

(6 Steps)

1. To display the Lift Status Screen, press both dash buttons (A) at the same time. (See Fig. 40)

2. To access the configuration screen, press the down button (B) on the hand control. (See Fig. 40)

Fig. 41

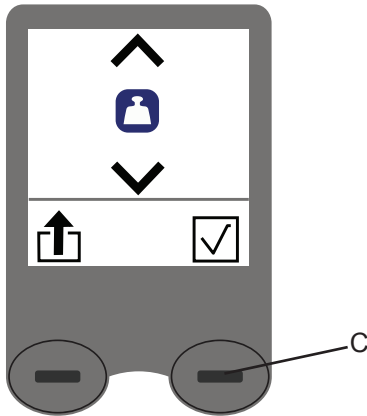

The Weight Unit screen will be displayed. (See Fig. 41)

Fig. 42

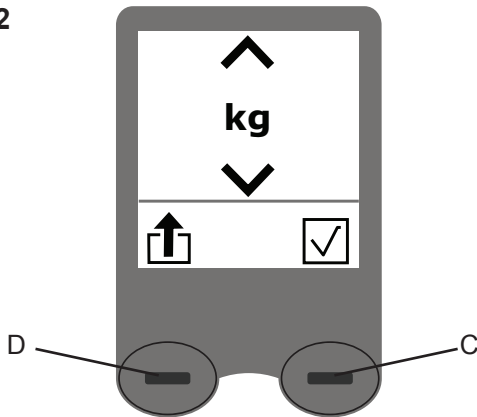

3. Press the right dash button (C) to access the units of measurement option. (See Fig. 42)

4. To switch between kg and lb, press the down button (B).

5. To save the settings and return to normal use, press the right dash button (C). (See Fig. 42)

6. Press the left dash button (D) to exit without saving changes. (See Fig. 42)

NOTE

It is not possible to change the units of mass on the Class III scale.

Battery Instructions

WARNING

To avoid bodily injury, do NOT crush, puncture, open, dismantle or otherwise mechanically interfere with the battery.

- Should the battery casing crack and cause contents to come in contact with skin or clothing, rinse immediately with plenty of water.
- If contents come in contact with the eyes, rinse immediately with plenty of water and seek medical attention.
- Inhalation of the contents can cause respiratory irritation. Seek fresh air and medical attention.

CAUTION

To avoid the battery from overheating and exploding, do NOT expose the battery to flames or excessive heat.

Sara Flex uses sealed lead-acid batteries mounted below the control panel. The LCD screen only shuts down after 2 minutes of inactivity. The rest of the electronics shuts down after 10 minutes of inactivity, to prevent battery damage or drainage while the lift is in the stand-by mode.

Low Battery Warning

Sara Flex has a battery charge indicator on the hand control. (See Fig. 43)

Fig. 43

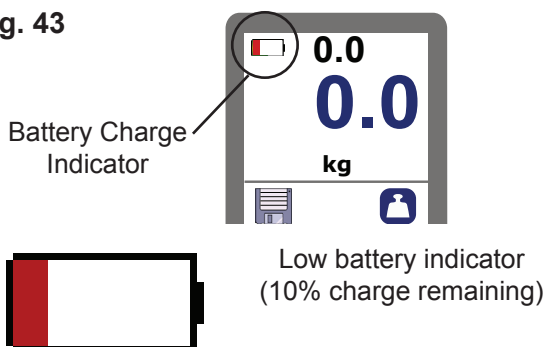

The battery indicator on the hand control will show if the batteries for *Sara Flex* are close to being empty and it will beep two times every minute. Complete the transfer and charge the battery.

If the battery is close to being empty, the unit will beep 3 times and only a large red low battery indicator will show on the display, then the lift will go into sleep mode.

When trying to use the lift with an almost empty battery:

- The unit will beep 3 times.
- The hand control will briefly display the low battery icon.
- The unit will go back to sleep mode.
- The lift will not be operable until the battery is recharged or replaced.

Storage of Battery

- The battery is delivered charged but it's recommend to recharge the battery when received, due to a slow discharge.
- The battery will slowly discharge when not used.
- A battery not in use should be stored in a temperature range of -0°C (32°F) to $+30^{\circ}\text{C}$ (86°F).
- For maximum battery performance do not store the battery above 50°C (122°F).

Charging Intervals

- To prolong the life of the battery, charge it at regular intervals, e.g. every night.
- It is recommended to use two batteries, one in operation and one as a stand-by in the charger.
- It is recommended that the battery not in use is left in the charger. There is no risk of overcharging the battery.
- It is recommended to remove the battery from the *Sara Flex* when it is not to be used for an extended period of time.
- To prolong the life of the battery, recharge it before it reaches a low level charge.

Inserting/Removing the Battery

The same method applies for inserting/removing the battery on the *Sara Flex* or the charger.

Fig. 44

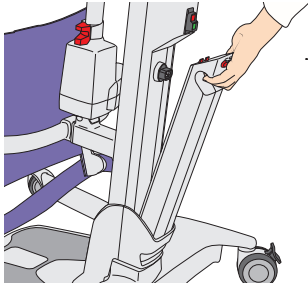

Inserting the Battery (2 Steps)

1. Place the battery in the battery rack. (See Fig. 44)
2. Push the top of the battery until it is in position. (See Fig. 45)

Fig. 45

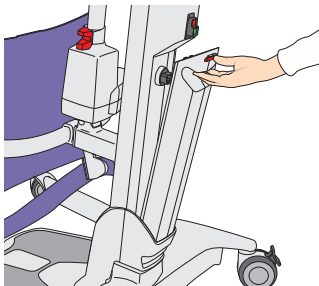

Removing the Battery (3 steps)

1. Push the release button. (See Fig. 46)
2. Pull the battery out. (See Fig. 45)
3. Lift the battery to detach it from the battery rack. (See Fig. 44)

Fig. 46

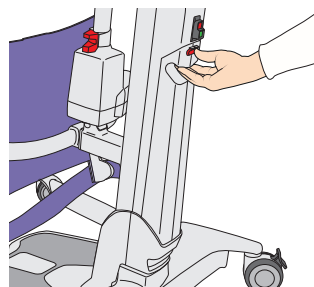

Battery Service Life

The battery life is around 2-5 years and is affected by charging practices and load exertion.

Installation of Charger

See respective *Battery Charger IFU*.

How to Charge the Battery

See respective *Battery Charger IFU*.

Cleaning and Disinfection Instructions

The following processes are recommended, but should be adapted to comply with the local or national guidelines (Decontamination of Medical Devices) which may apply within the Healthcare Facility or the country of use. If uncertain, seek advice from the local Infection Control Specialist.

Sara Flex should be routinely cleaned and disinfected between patients and at regular intervals while in use; as is good practice for all reusable medical devices.

If there are any questions regarding cleaning and disinfecting the equipment, or wish to order disinfectant fluid, contact Arjo Customer Service. See section, Parts and Accessories. Make sure to have the Safety Data Sheets (SDS) available for the disinfectants being used.

WARNING



To avoid eye and skin damage, always use protective glasses and gloves. If contact occurs, rinse with plenty of water. If eyes or skin becomes irritated, contact a physician. Always read the instructions for use and material safety data sheet of the disinfectant.

WARNING

To prevent cross-contamination, always follow the disinfection instructions in this Instructions for Use.

WARNING

To avoid eye or skin irritation, never disinfect in the presence of a patient.

Detergents/Disinfectants

- Mild neutral detergent
- Alcohol (Ethyl or Isopropyl) 70-90%
- Chlorine (10 000ppm free chlorine)
- Phenols (as per Manufacturer's Recommendation)
- Quaternary Ammonium (as per Manufacturer's Recommendation)
- Hydrogen Peroxide (<4.5%) can be used, but may cause discoloration on the Sara Flex.

Accessories Needed for Cleaning/Disinfection

- Protective glasses
- Protective gloves
- Spray bottle with water
- Disposable towels
- Brush

Cleaning/Disinfection

Follow this procedure between every use.

Follow these 14 steps

Preparation (step 1)

1. Place *Sara Flex* in an ergonomic working position.

Removal of visible contamination (step 2-3)

2. Wet a disposable towel with water and remove visible stains and soil on *Sara Flex*.
3. If heavily contaminated, please use brush and towels to remove all visible contamination.

Cleaning (step 4-8)

4. Spray with Arjo verified detergent, see “*Detergents/Disinfectants*” on page 27 on all parts of *Sara Flex* and on the hand control.
5. Wet a disposable towel with water and remove all traces of the detergent. For the leg support (A) and leg strap (B), use a disposable towel to remove the detergent and for the footplate (C), you may need a brush. (See Fig. 47)
6. If the detergent cannot be removed, spray water on the affected part and then wipe it off with disposable towels.
7. Repeat until all of the detergent has been removed.
8. Let all parts dry.

Disinfection (step 9-14)

9. Repeat spraying with the Arjo verified disinfectant on all parts and on the hand control.
10. Allow the disinfectant to stay on the parts according to manufacturer’s recommendation.
11. Remove all traces of disinfectant, using new wet disposable towels. For the leg support (A) and leg strap (B), use a disposable towel to remove the disinfectant and for the footplate (C), you may need a brush. (See Fig. 47)
12. If the disinfectant cannot be removed, spray with water on the affected part and wipe it off with disposable towels.
13. Repeat until all of the disinfectant has been removed.
14. Let all parts dry.

Fig. 47

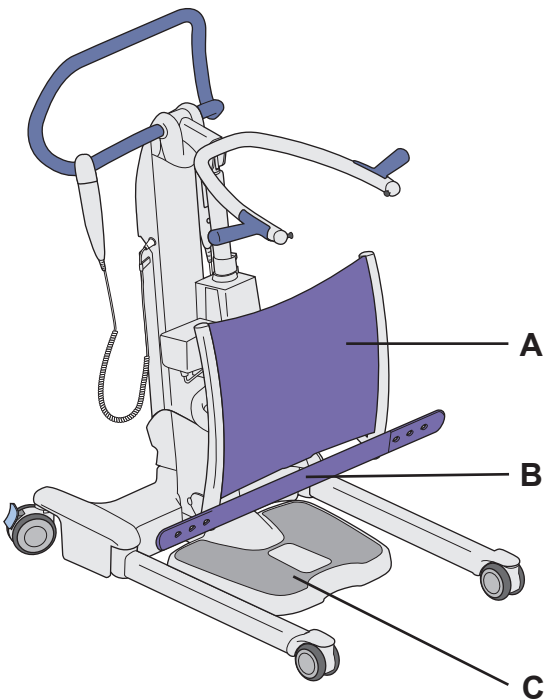

Troubleshooting

Problem Description	Solution
Hand control does not respond	<ul style="list-style-type: none"> • Check that the Emergency stop button on the control box is not pushed. • Check the connector on hand control cord. • Check the battery condition (replace with a fully charged battery pack).
UP and DOWN buttons on control box do not respond	<ul style="list-style-type: none"> • Check that the Emergency stop button on the control box is not pushed. • Check the battery condition (replace with a fully charged battery pack).
The control box beeps two times every 30 seconds and the red empty battery icon will show in the upper left corner of the display	Battery is low. Replace with a freshly charged battery pack.
The control box beeps three times and only a large red low battery indicator will show on the display and then the lift shuts-off.	Battery is low. Replace with a freshly charged battery pack.
The control box beeps more than three times in conditions other than those mentioned above.	Call Arjo for service.
Actuators “stalls” during operation	Battery is low. Replace with a freshly charged battery. Do not exceed the lifting capacity.

Care and Preventive Maintenance

Sara Flex is subject to wear and tear, and the following actions must be performed when specified to make sure that the product remains within its original manufacturing specification.

WARNING

To avoid malfunction resulting in injury, make sure to conduct regular inspections and follow the recommended maintenance schedule. In some cases, due to heavy use of the product and exposure to aggressive environment, more frequent inspections should be carried out.

Local regulations and standards may be more stringent than the recommended maintenance schedule.

WARNING

To avoid injury to both the patient and the caregiver, never modify the equipment or use incompatible parts.

SCHEDULE	Between Every Use	Every Week	Every Year
Caregiver Obligations Action/Check			
Cleaning/Disinfection	x		
Examine the sling, straps and clips for damage or fraying as required.	x		
Check to make sure the patient/resident handles are secure.	x		
Visually check exposed surfaces for damage, sharp edges, etc.		x	
Visually check sling attachment points. Do not use if damaged.		x	
Make sure all labels are attached.		x	
Visually check the hand control and cable for damage.		x	
Perform a full functionality test on <i>Sara Flex</i> .		x	
Check operation of the Emergency Stop/Power Button and the Emergency Lowering Handle		x	
Check battery for leakage and/or deterioration. Replace if needed.		x	
Check all castors for wear.		x	
Check for evidence of corrosion.		x	
Yearly checks by qualified service personnel only.			x

Caregiver Obligations

Between Every Use

Cleaning and disinfection

- *Sara Flex* has to be cleaned and disinfected immediately after usage
- For further disinfecting instructions, see section “*Cleaning and Disinfection Instructions*” on page 27.

Examine the sling, strap and clips for damage or fraying as required

- See respective sling *IFU* .

Check to make sure the patient/resident handles are secure

- Grab the patient/resident handles (**D**) firmly, rotate them and push them outward. (See Fig. 48)

Every Week

Visually check exposed surfaces for damage, sharp edges, etc.

- Pay close attention to all the parts that are in contact with the patient: foot plate (**A**), leg strap (**B**), leg support (**C**), patient/resident handles (**D**). (See Fig. 48)
- Look for tears in the leg support and leg strap.
- Look for any deformation in structural parts.

Visually check sling attachment points. Do not use if damaged

- Check the slings for fraying, cuts or loose stitching.

Fig. 48

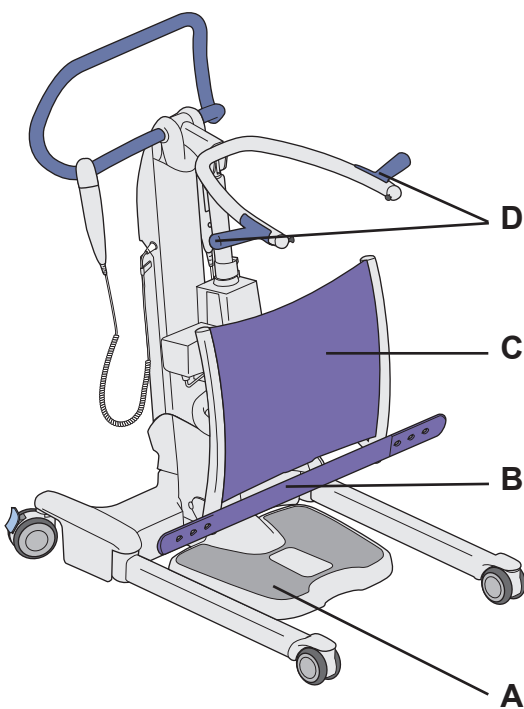

Make sure all labels are attached

- Check if all labels are attached on the *Sara Flex* according to “Labels on Sara Flex” on page 37.

Visually check the hand control and cable for damage

- Check the hand control screen for dead pixels or any other display defects.

Fig. 49

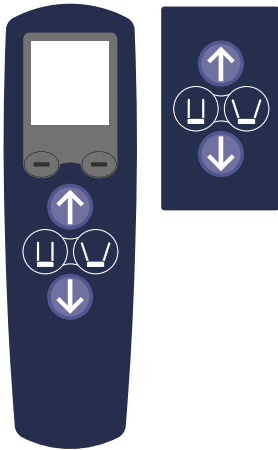

Perform a full functionality test on Sara Flex

- Raise the lifting arm to its highest position using the hand control or the control panel.
- Lower the lifting arm to its lowest position using the hand control or the control panel.
- Test every button on the hand control and the control panel. (See Fig. 49)
All buttons must be working according to “Controls and Features” on page 9.
- Move the *Sara Flex* around on a flat surface and make sure that the four castors are in contact with the ground.
- Make sure to test the brakes. Activate the brakes and try to move the *Sara Flex* around.
- Check for abnormal sounds during movements.

Fig. 50

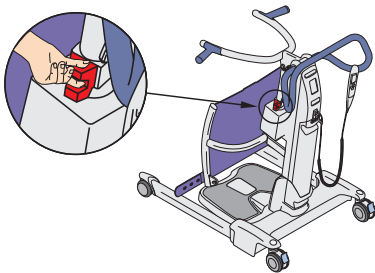

Check operation of the Emergency Stop/Power Button and the Emergency Lowering Handle

- Raise the lifting arm.
- Push the lifting arm down while pulling up the Emergency Lowering handle. The lifting arm should lower slowly. (See Fig. 50)
- While raising/lowering the lifting arm or opening/closing the legs, press the Emergency Stop/Power Button (A). The lift movement should stop immediately. (See Fig. 51)

Fig. 51

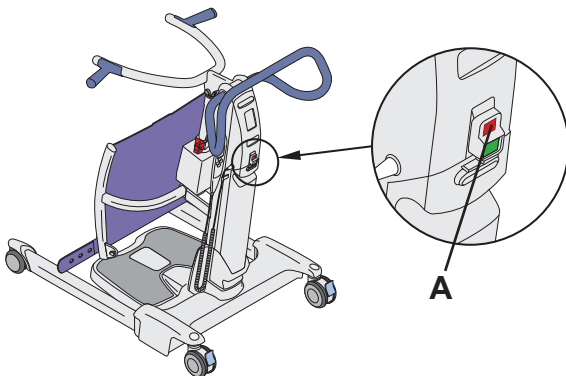

Check battery for leakage and/or deterioration. Replace if needed

- Remove the battery.
- Check the battery connector for any damage.
- Visually inspect the battery and look for leakage and/or deterioration.

Check all castors for wear

- Clean the castors with water (their functionality can be affected by soap, hair, dust and chemicals from floor cleaning).
- Check that the castors are rolling and swiveling freely.

Check for evidence of corrosion

If there is any visible corrosion or damage on parts, contact your local Arjo representative for support.

Yearly Checks by Qualified Personnel only

Sara Flex must be serviced once a year in accordance with the Maintenance and Repair Manual.

WARNING

To avoid injury and/or unsafe product, the maintenance activities must be carried out at the correct frequency by qualified personnel using correct tools, parts and knowledge of procedures. Qualified personnel must have documented training in maintenance of this device.

NOTE

All Caregiver Obligations are to be checked when performing the Qualified Personnel Service.

For details, see separate service instructions.

Technical Specifications

General	
Safe working load (SWL) <i>Sara Flex</i>	200 kg / 440 lb
Component Weight <i>Sara Flex</i> complete	52 kg / 114.5 lb
Battery Pack	3.8 kg / 8.4 lb
Electrical	
Degree of protection - Electrical Shock	Type BF 
Lift - Protection Class	IP24
Hand Control - Protection Class	IPX7
Battery Type	Rechargeable - sealed lead acid
Battery Part Number	NDA0100-20
Battery capacity	24V DC 4Ah
Battery Charger	NDA8200
Lift - Protection Class - shock protection	Internally powered equipment
Lift nominal voltage	24V DC
Fuse	15A type AGC fuse
Operating force of controls	< 5 N
Max Duty Cycle, Lift Actuator	10% MAX (2 min ON / 18 min OFF)
Max Duty Cycle, Leg Spread Actuator	10% MAX (2 min ON / 18 min OFF)
Maximum sound power level	50dB
Scale specification	
Weight range	200 kg / 440 lb
Display resolution and type	0.2 kg / 0.5 lb, liquid crystal display
Operating conditions	
Ambient temperature	+10°C (50°F) to +40°C (104°F)
Relative humidity range	10% to 80%
Atmospheric Pressure	700 hPa to 1060 hPa
Transport and Storage	
Ambient temperature	-25°C (-13°F) to +70°C (158°F)
Relative humidity range	10% to 80%
Atmospheric Pressure	700 hPa to 1060 hPa
When transporting the product from one facility to another, make sure the product is properly secured.	

Safe Disposal	
Battery	Lead-Acid Not for disposal. Environmental danger.
Package	Wood and corrugated cardboard, recyclable.
Product	Electric, Metal and Plastic Parts shall be separated and recycled according to marking on the unit.
Electrical and electronic components	Lift systems having electrical and electronic components or an electrical cord should be disassembled and recycled per Waste of Electrical and Electronic Equipment (WEEE) or in accordance with local or national regulation.
Slings	Slings including stiffeners/ stabilizers, padding material, any other textiles or polymers or plastic materials etc. should be sorted as combustible waste.

Allowed Combinations	
Active Sling	<ul style="list-style-type: none"> • TSS.500 (S) • TSS.501 (M) • TSS.502 (L) • TSS.503 (XL) • TSS.504 (XXL)
Transfer Sling	• TSS.511 (Only to be used with Central Hook)
Flite	• MFA3000

Dimensions

Measurements in mm and inches (“)

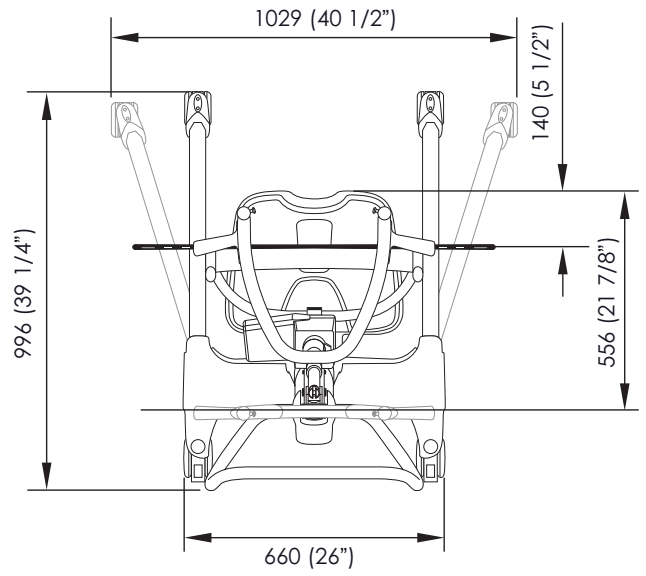
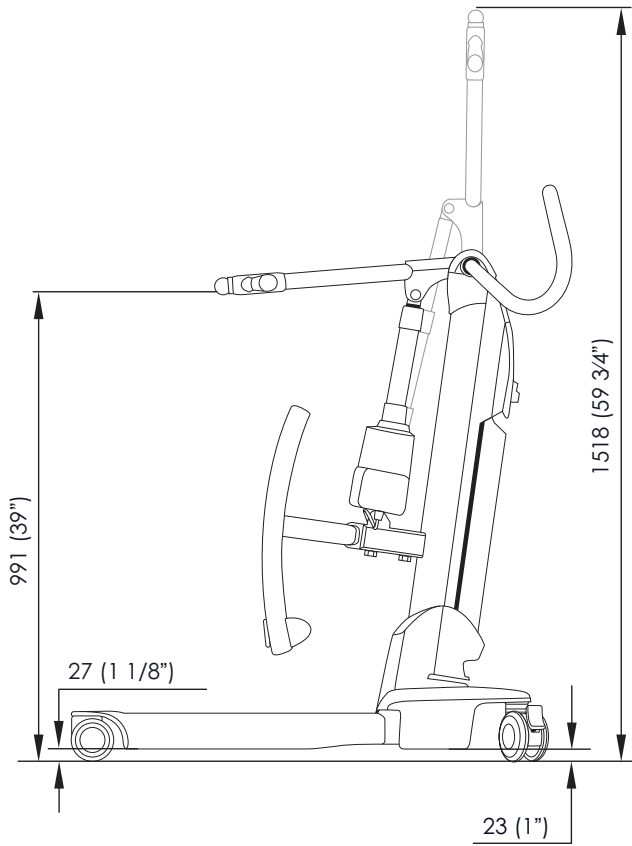

Turning radius

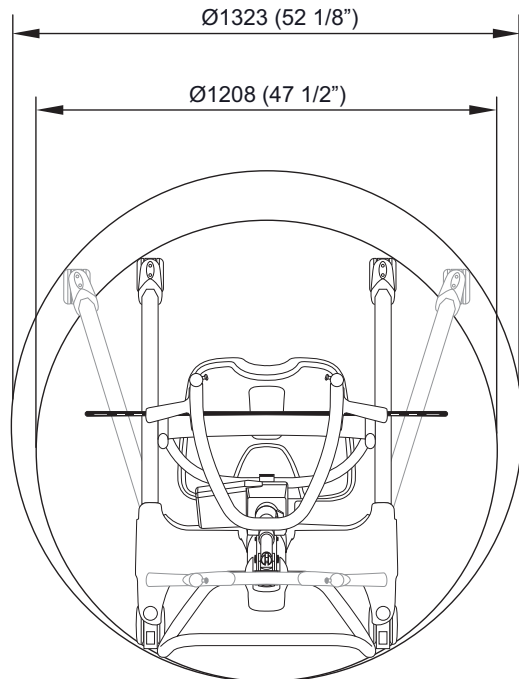
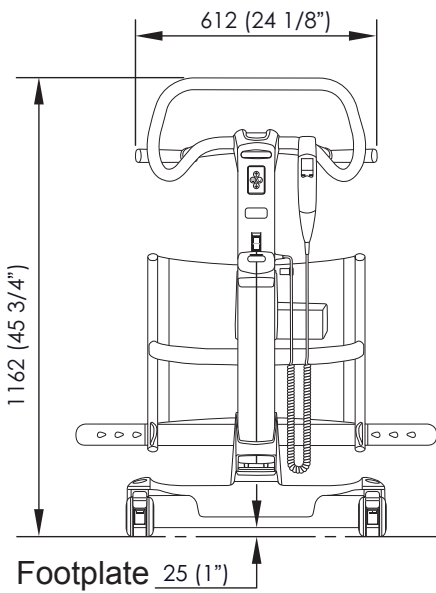



Labels on Sara Flex











On the labels you can find the following symbols / information:

Label explanation

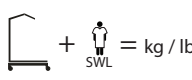
Data Label	States technical performance and requirements, e.g. Input Power, Input Voltage and maximum patient Weight etc.
Identification Label	States the product identification, serial number and year and month of manufacturing.
SWL Label	This label indicates the maximum lifting capacity of <i>Sara Flex</i>
Battery Label	States safety and environmental information for the battery.
Weighing Parameters Scale Label	This label states the weighing parameters for the scale.

Symbol explanation

SWL	Safe Working Load Defines the maximum total load of patient or any other load that may be on <i>Sara Flex</i>
IP24	Degree of protection against splashing water
24 V 	Supply voltage (DC)
10 A	Current
	Waste Electrical and Electronic Equipment (WEEE) - do not dispose of this product in general household or commercial waste.
REF	Model number
SN	Serial number
	Manufacturer name and address

	Read the <i>IFU</i> before use
	Type BF protection against electrical shock in accordance with IEC 60601-1
	CE marking in accordance with The Medical Devices Directive 93/42/EEC.
	Certified according to NRTL through TÜV SÜD. See section, List of Standards and Certificates..
	Certified through TÜV SÜD. See section, List of Standards and Certificates.
	Total mass of equipment including its safe working load (52kg/116lb+200kg/440lb =252kg / 556lb).
	SWL Rating Indicates the maximum lifting capacity of the lift.
	Scale symbol. If the lift has this symbol, the scale function is installed.
Max	Maximum capacity of the weighing instrument
Min	Minimum capacity of the weighing instrument
e	Verification scale interval
	Do not push or pull on the actuator
	Non-automatic weighing instrument label Class III; yy = year; XXXX = Notified Body Number.
	Indicates the product is a Medical Device according to EU Medical Device Regulation 2017/745

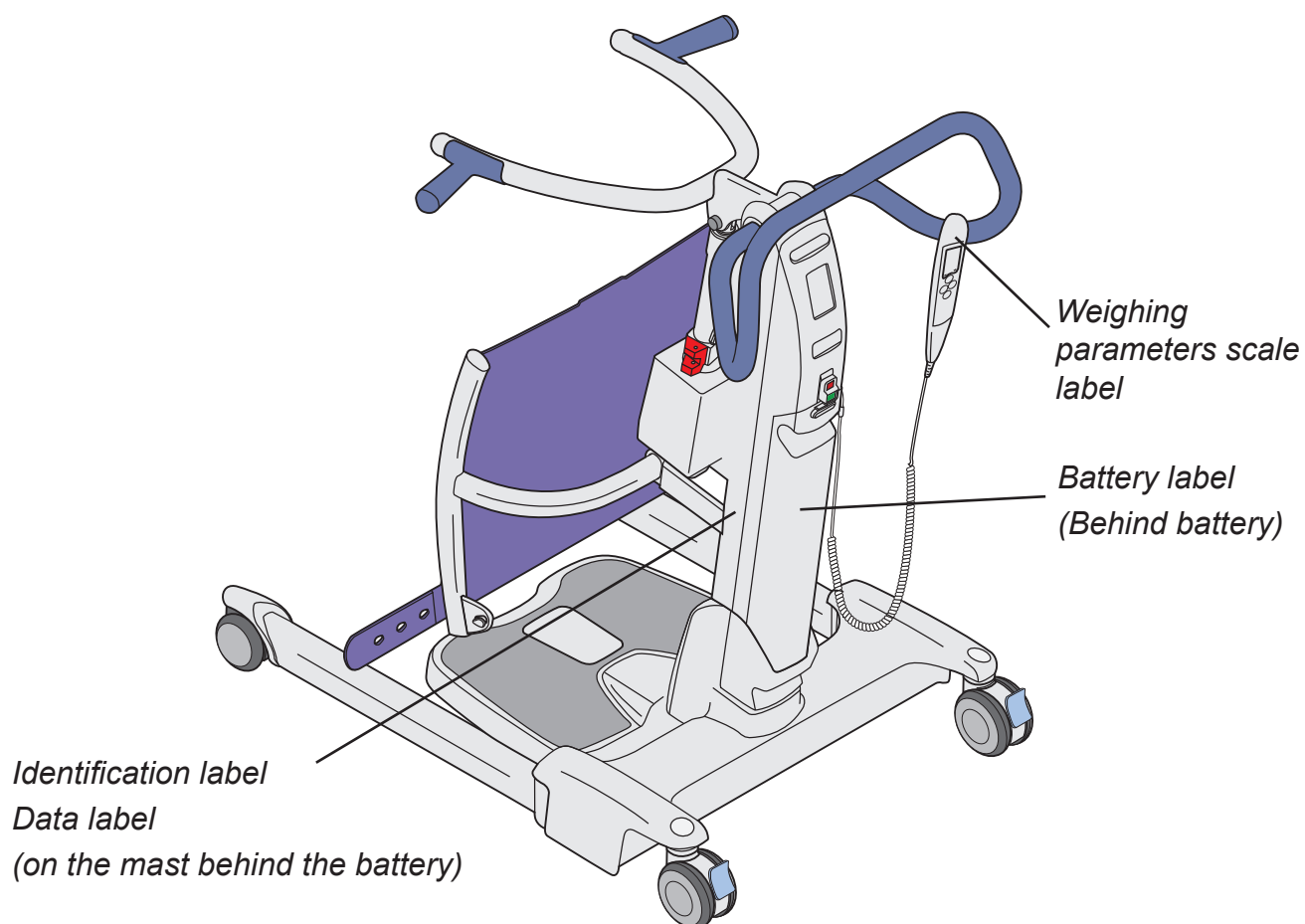
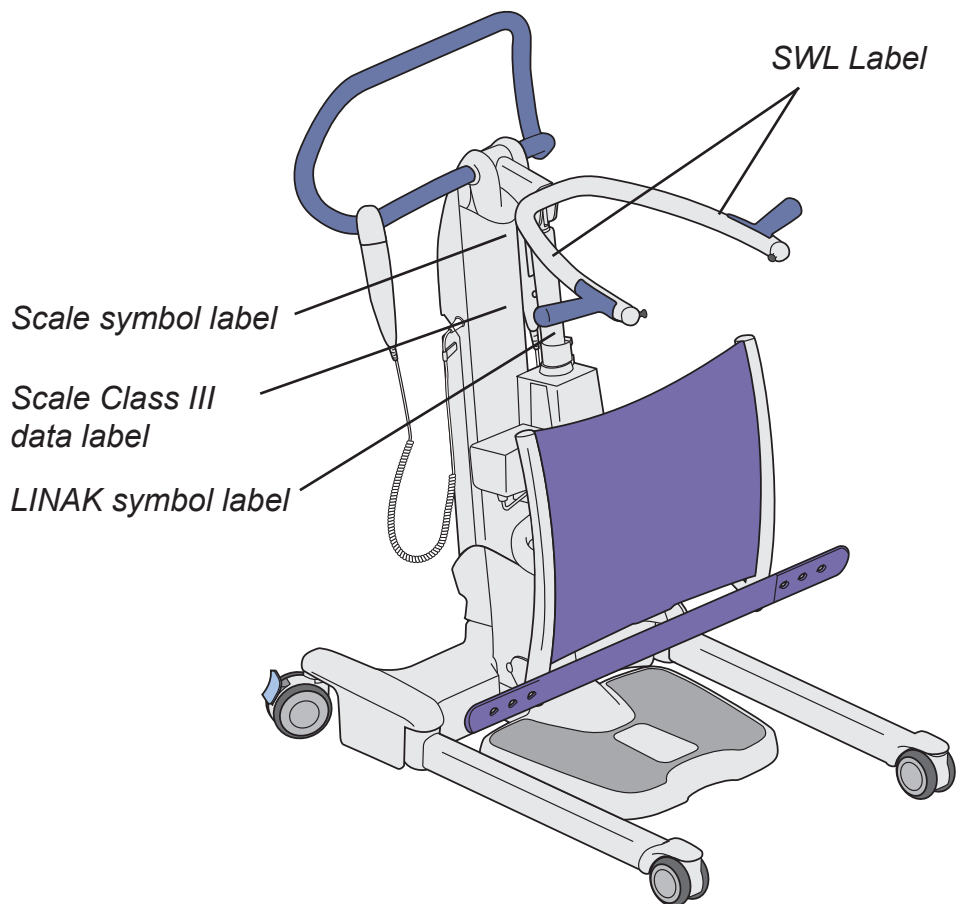

List of Standards and Certificates

STANDARDS/ CERTIFICATE	DESCRIPTION
EN/IEC 60601-1 (TÜV SÜD)	Medical electrical equipment
EN ISO 10535: 2006 (TÜV SÜD)	Hoists for the transfer of disabled persons - Requirements and test methods.
BS EN 45501:2015	Metrological aspects of non-automatic weighing instruments.
OIML R 76-1:2006	Non-automatic weighing instruments Part1: Metrological and technical requirements.

Electromagnetic Compatibility

Sara Flex has been tested for compliance with current regulatory standards regarding its capacity to block EMI (electromagnetic interference) from external sources. Nonetheless, some procedures can help reduce electromagnetic interferences:

- Ensure that other devices in patient-monitoring and/or life-support areas comply to accepted emissions standards.
- Maximize the distance between electro-medical devices. High-powered devices may produce EMI that can affect the lift.

For more information on how to manage the unit’s RF electromagnetic environment, please consult the AMI TIR 18-1997 - Guidance on Electromagnetic Compatibility of Medical Devices for Clinical/ Biomedical Engineers.

Sara Flex is intended for the use in the electromagnetic environment specified below. The customer or the user of *Sara Flex* should assure that it is used in such an environment.

WARNING

Portable RF communications equipment (including peripherals such as antenna cables and external antennas) should be used no closer than 30 cm to any part of the Sara Flex including cables specified by the manufacturer. Otherwise, performance degradation of this equipment could result.

WARNING

Use of accessories, cables and spare parts other than those specified or provided by Arjo could result in increased electromagnetic emissions or decreased electromagnetic immunity of this equipment and result in improper operation.

WARNING

Use of this equipment adjacent to or stacked with other equipment should be avoided because it could result in improper operation. If such use is necessary, this equipment and the other equipment should be observed to verify that they are operating normally.

WARNING

The equipment may cause radio interference or may disrupt the operation of nearby equipment. It may be necessary to take action, such as reorienting, relocating the equipment or shielding the location.



Guidance and manufacturer’s declaration: electromagnetic emissions

Emissions test	Compliance	Electromagnetic environment - guidance
RF emissions CISPR 11	Group 1	<i>Sara Flex</i> uses RF energy only for its internal function. Therefore, its RF emissions are very low and are not likely to cause any interference in nearby electronic equipment.
RF emissions CISPR 11	Class B	<i>Sara Flex</i> is suitable for use in all establishments, including domestic establishments and those directly connected to the public low voltage power supply network that supplies buildings used for domestic purposes.

Guidance and manufacturer's declaration: electromagnetic immunity

Immunity test	IEC60601 test level	Compliance level	Electromagnetic environment - guidance
Electrostatic discharge (ESD) IEC 61000-4-2	±8kV contact ±15kV air	±8kV contact ±15kV air	Floors should be wood, concrete or ceramic tile. If floors are covered with synthetic material the relative humidity level should be at least 30%
Conducted RF IEC 61000-4-6	3 V outside ISM bands between 0.15-80 MHz 6 V inside ISM and amateur radio bands between 0.15 - 80 MHz	3 V outside ISM bands between 0.15-80 MHz 6 V inside ISM and amateur radio bands between 0.15 - 80 MHz	N/A
Radiated RF IEC 61000-4-3	10V/m 80MHz to 2.7GHz	10V/m 80MHz to 2.7GHz	
Electrical fast transient/burst IEC 61000-4-4	±1 kV, I/O Ports 100 kHz repetition frequency	±1 kV, I/O Ports 100 kHz repetition frequency	Mains power supply should be that of a typical commercial or hospital environment.
Power frequency (50/60 Hz) Magnetic field IEC 61000-4-8	30 A/m 50/60 Hz	30 A/m 50/60 Hz	If functional disturbance occurs on <i>Sara Flex</i> it may be necessary to install magnetic shielding. The power frequency magnetic field should be measured prior to installation to assure that it is sufficiently low.
Proximity fields from RF wireless communications equipment IEC 61000-4-3	380 - 390 MHz 27 V/m; PM 50%; 18 Hz 430 - 470 MHz 28 V/m; (FM ±5 kHz, 1 kHz sine) PM; 18 Hz 704 - 708 MHz 9 V/m; PM 50%; 217 Hz 800 - 960 MHz 28 V/m; PM 50%; 18 Hz 1700 - 1990 MHz 28 V/m; PM 50%; 217 Hz 2400 - 2570 MHz 28 V/m; PM 50%; 217 Hz 5100 - 5800 MHz 9 V/m; PM 50%; 217 Hz	380 - 390 MHz 27 V/m; PM 50%; 18 Hz 430 - 470 MHz 28 V/m; (FM ±5 kHz, 1 kHz sine) PM; 18 Hz 704 - 708 MHz 9 V/m; PM 50%; 217 Hz 800 - 960 MHz 28 V/m; PM 50%; 18 Hz 1700 - 1990 MHz 28 V/m; PM 50%; 217 Hz 2400 - 2570 MHz 28 V/m; PM 50%; 217 Hz 5100 - 5800 MHz 9 V/m; PM 50%; 217 Hz	N/A

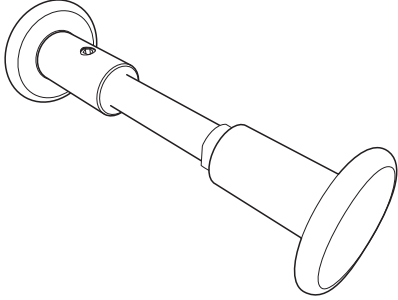
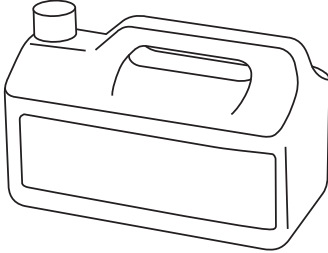
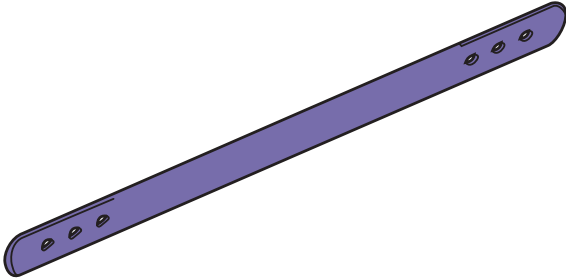
Parts and Accessories

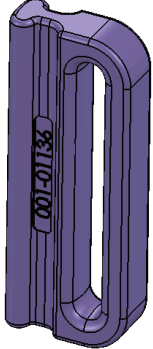
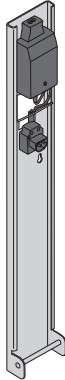
	
<p>Central Hook 700-27041</p>	<p>Disinfectant To order, contact local representative</p>
	
<p>Leg Strap AH1003006</p>	<p>Battery NDA0100-20</p>
	
<p>Leg Strap Attachment 700-27044</p>	<p>Battery Charger NDA8200</p>

AUSTRALIA
Arjo Australia
Building B, Level 3
11 Talavera Road
Macquarie Park, NSW, 2113,
Australia
Phone: 1800 072 040

BELGIQUE / BELGIË
Arjo Belgium nv
Evenbroekveld 16
9420 Erpe-Mere
Belgium
T: +32 (0) 53 60 73 80
F: +32 (0) 53 60 73 81
E-mail: info.belgium@arjo.com

BRASIL
Arjo Brasil Equipamentos Médicos Ltda
Rua Marina Ciufuli Zanfelice, 329 PB02 Galpão
- Lapa
São Paulo – SP – Brasil
CEP: 05040-000
Phone: 55-11-3588-5088
E-mail: vendas.latam@arjo.com
E-mail: servicios.latam@arjo.com

CANADA
Arjo Canada Inc.
90 Matheson Boulevard West
Suite 300
CA-MISSISSAUGA, ON, L5R 3R3
Tel/Tél: +1 905 238 7880
Free: +1 800 665 4831 Institutional
Free: +1 800 868 0441 Home Care
Fax: +1 905 238 7881
E-mail: info.canada@arjo.com

ČESKÁ REPUBLIKA
Arjo Czech Republic s.r.o.
Na Strži 1702/65
140 00 Praha
Czech Republic
Phone No: +420225092307
e-mail: info.cz@arjo.com

DANMARK
Arjo A/S
Vassingerødvej 52
DK-3540 LYNGE
Tel: +45 49 13 84 86
Fax: +45 49 13 84 87
E-mail:
dk_kundeservice@arjo.com

DEUTSCHLAND
Arjo GmbH
Peter-Sander-Strasse 10
DE-55252 MAINZ-KASTEL
Tel: +49 (0) 6134 186 0
Fax: +49 (0) 6134 186 160
E-mail: info-de@arjo.com

ESPAÑA
Arjo Ibérica S.L.
Parque Empresarial Rivas Futura, C/Marie
Curie 5
Edificio Alfa Planta 6 oficina 6.1-.62
ES-28521 Rivas Vacia, MADRID
Tel: +34 93 583 11 22
Fax: +34 93 583 11 22
E-mail: info.es@arjo.com

FRANCE
Arjo SAS
2 Avenue Alcide de Gasperi
CS 70133
FR-59436 RONCQ CEDEX
Tél: +33 (0) 3 20 28 13 13
Fax: +33 (0) 3 20 28 13 14
E-mail: info.france@arjo.com

HONG KONG
Arjo Hong Kong Limited
Room 411-414, 4/F, Manhattan Centre,
8 Kwai Cheong Road, Kwai Chung, N.T.,
HONG KONG
Tel: +852 2960 7600
Fax: +852 2960 1711

ITALIA
Arjo Italia S.p.A.
Via Giacomo Peroni 400-402
IT-00131 ROMA
Tel: +39 (0) 6 87426211
Fax: +39 (0) 6 87426222
E-mail: Italy.promo@arjo.com

MIDDLE EAST
Arjo Middle East FZ-LLC
Office 908, 9th Floor,
HQ Building, North Tower,
Dubai Science Park,
Al Barsha South
P.O Box 11488, Dubai,
United Arab Emirates
Direct +971 487 48053
Fax +971 487 48072
Email: Info.ME@arjo.com

NEDERLAND
Arjo BV
Biezenwei 21
4004 MB TIEL
Postbus 6116
4000 HC TIEL
Tel: +31 (0) 344 64 08 00
Fax: +31 (0) 344 64 08 85
E-mail: info.nl@arjo.com

NEW ZEALAND
Arjo Ltd
34 Vestey Drive
Mount Wellington
NZ-AUCKLAND 1060
Tel: +64 (0) 9 573 5344
Free Call: 0800 000 151
Fax: +64 (0) 9 573 5384
E-mail: nz.info@Arjo.com

NORGE
Arjo Norway AS
Olaf Helsets vei 5
N-0694 OSLO
Tel: +47 22 08 00 50
Faks: +47 22 08 00 51
E-mail: no.kundeservice@arjo.com

ÖSTERREICH
Arjo GmbH
Lemböckgasse 49 / Stiege A / 4.OG
A-1230 Wien
Tel: +43 1 8 66 56
Fax: +43 1 866 56 7000

POLSKA
Arjo Polska Sp. z o.o.
ul. Ks Piotra Wawrzyniaka 2
PL-62-052 KOMORNIKI (Poznań)
Tel: +48 61 662 15 50
Fax: +48 61 662 15 90
E-mail: arjo@arjo.com

PORTUGAL
Arjo em Portugal
MAQUET Portugal, Lda.
(Distribuidor Exclusivo)
Rua Poeta Bocage n.º 2 - 2G
PT-1600-233 Lisboa
Tel: +351 214 189 815
Fax: +351 214 177 413
E-mail: Portugal@arjo.com

SUISSE / SCHWEIZ
Arjo AG
Fabrikstrasse 8
Postfach
CH-4614 HÄGENDORF
Tél/Tel: +41 (0) 61 337 97 77
Fax: +41 (0) 61 311 97 42

SUOMI
Arjo Scandinavia AB
Riihitontuntie 7 C
02200 Espoo
Finland
Puh: +358 9 6824 1260
E-mail: Asiakaspalvelu.finland@arjo.com

SVERIGE
Arjo International HQ
Hans Michelsensgatan 10
SE-211 20 MALMÖ
Tel: +46 (0) 10 494 7760
Fax: +46 (0) 10 494 7761
E-mail: kundservice@arjo.com

UNITED KINGDOM
Arjo UK and Ireland
Houghton Hall Park
Houghton Regis
UK-DUNSTABLE LU5 5XF
Tel: +44 (0) 1582 745 700
Fax: +44 (0) 1582 745 745
E-mail: sales.admin@arjo.com

USA
Arjo Inc.
2349 W Lake Street Suite 250
US-Addison, IL 60101
Tel: +1 630 307 2756
Free: +1 800 323 1245 Institutional
Free: +1 800 868 0441 Home Care
Fax: +1 630 307 6195
E-mail: us.info@arjo.com

JAPAN
Arjo Japan K.K.
東京都港区虎ノ門三丁目7番8号 ランディッ
ク第2虎ノ門ビル9階
電話 : +81 (0)3-6435-6401

Address page - REV 25: 01/2020

At Arjo, we are committed to improving the everyday lives of people affected by reduced mobility and age-related health challenges. With products and solutions that ensure ergonomic patient handling, personal hygiene, disinfection, diagnostics, and the effective prevention of pressure ulcers and venous thromboembolism, we help professionals across care environments to continually raise the standard of safe and dignified care. Everything we do, we do with people in mind.



ArjoHuntleigh AB
Hans Michelsensgatan 10
211 20 Malmö, Sweden
www.arjo.com

arjo



04.KL.00.EN

CE
2797